



Instruction
manual

EXAPad

EXAPad^{mini}



Contents

1. Start Up	3
2. Scanner Quick Guide	4
3. Settings	5
4. B-Mode Imaging	9
5. CFM - Mode Imaging	11
6. PW Doppler - Mode Imaging	12
7. CW Doppler - Mode Imaging	13
8. Power Doppler - Mode Imaging	14
9. M-Mode Imaging	15
10. ECG - Electrocardiogram	16
11. Freeze Mode and Cineloop	17
12. Storing of Images and Clips, Review	21
13. Measurements	25
14. Applications and Presets	29
15. Patient File	31
16. Protocols	33
17. Webcam	34
18. Report	34
19. EchoPad App	35
20. Peripheral Connectivity	37
21. Care and Maintenance	38
22. Service Centres	39

1. Start Up

1.1 Stand set-up

When used without the trolley, the ExaPad must be placed on a supportive base.

In order to use the stand on the system, click on the black button as indicated below:

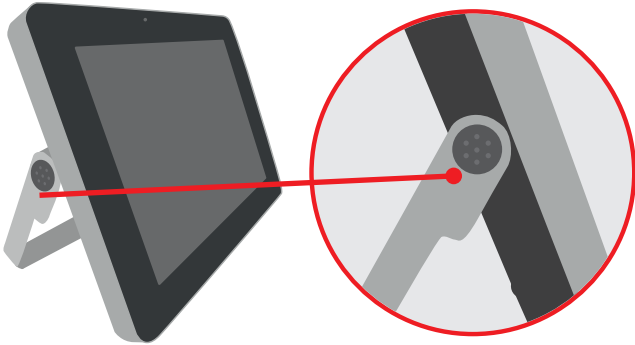

The fixing notches are unlocked and you can move the stand to one of 4 positions.

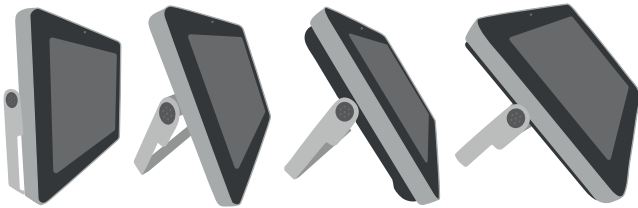

1.2 Connection and disconnection of probes

To connect a probe, place the probe connector in the opening at the back of the scanner, with the cable pointing outwards. Turn the lock situated in the middle of the connector with slight pressure in order to engage the locking mechanism. When the locking mechanism is engaged, make a quarter turn clockwise so that the probe is connected.

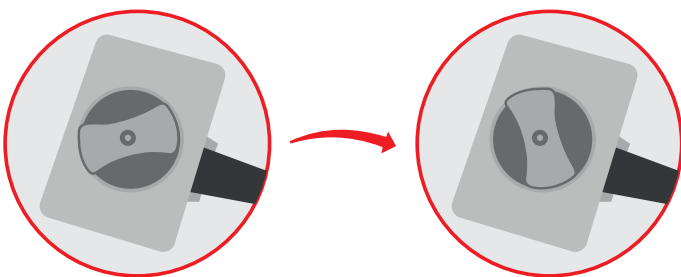

After connecting a probe, always place the probe in a safe place (either on the probe holders situated on the two upper corners of the device itself or in the probe holders on the optional trolley) in order to avoid any damage of the probe from a shock or drop.

The probes can be changed during the examination without restarting the device.

To disconnect a probe, make a quarter turn anti-clockwise in order to unlock the connector. Take the connector out of the device and store the probe, protected from shocks.

- Before disconnecting the active probe, make sure you freeze the image.
- When starting the device, always make sure to have a probe connected on the scanner.
- The name of the connected probe is indicated on the screen in the top right corner.

1.3 Starting of the device

Only use the power-supply adaptor supplied by IMV imaging.

To start the equipment, press the ON button located at the back of the device.

Then wait until the system starts and displays the user interface on the screen.

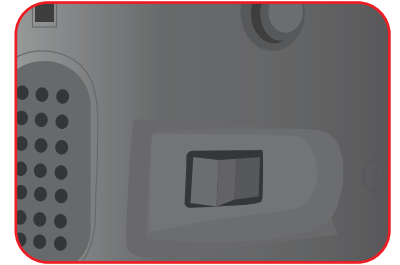

The ExaPad equipment starts in a preset mode corresponding to the connected probe. If no probe is connected, the system will display a message "No probe". In this case, connect a probe and click on the probe's name in the top right corner of the screen.

To turn off the scanner, long press on  situated in the top left corner of the screen, a shutdown procedure will be performed.

A forced shutdown of the device can be done by pressing the ON switch located at the back of the scanner.

Forced shutdown should only be done when scanner is malfunctioning.

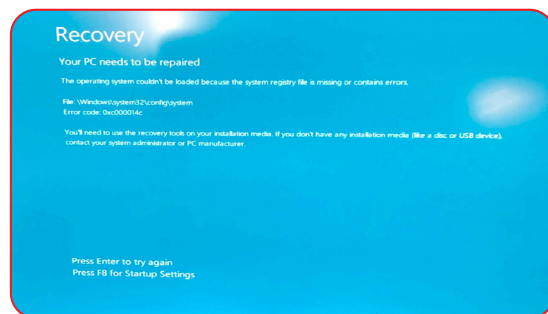

After 3 forced shutdowns in a row, a blue screen will appear.

If you are presented with the blue screen, follow the on-screen instructions. You may be able to restart, in cases where you cannot restart, contact your nearest service centre.

1.4 Battery

The ExaPad battery can be removed with the slider located on the back of the scanner. When inserting the battery pack in the device, check that it is securely connected.

When the device is plugged into mains electricity, the battery is charging regardless of whether the scanner is on or not.

While the battery is charging, a charging indicator is displayed in the upper right corner of the screen. There is also an indicator on the back left of the scanner;

 A green led indicates device is turned on.

 A blue led indicates when the hard disk is working.

 A yellow led indicates the battery is charging.

A warning message will appear when the battery is lower than 10%. Connect to a power supply or the scanner will shut down.

2. Scanner Quick Guide

2.1 Screen

The ExaPad scanner has a full touch-screen interface.

The ExaPad scanner turns on in B imaging mode with a screen display as below:

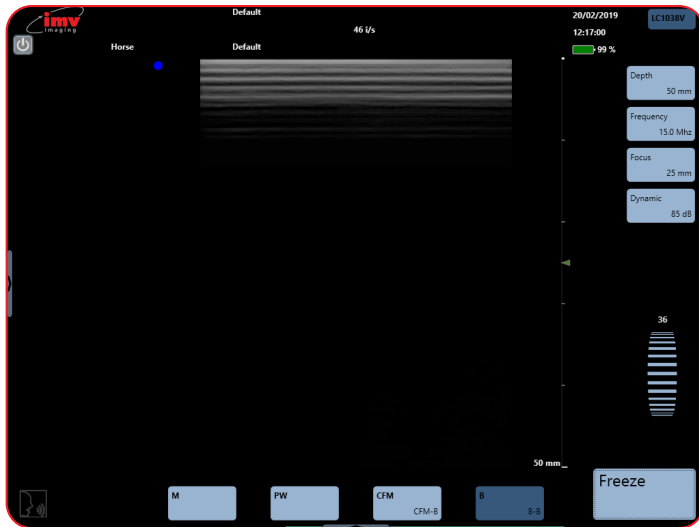

2.2 Access to the controls of the scanner

You can access the available imaging modes by clicking on the corresponding mode: **B, CFM, PW, Power, CW, M, Anatomic M.**

4 modes are visible at the one time. Drag the mode menu to access other imaging modes. The order of the modes can be configured in the Setting page (see Settings: Page 5).

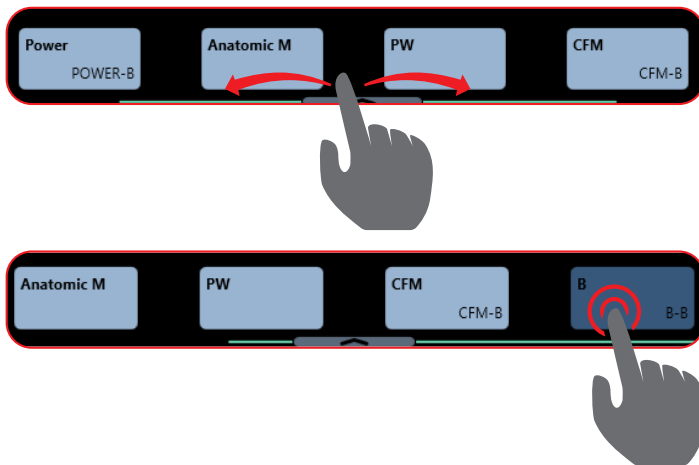

2.3 Menus

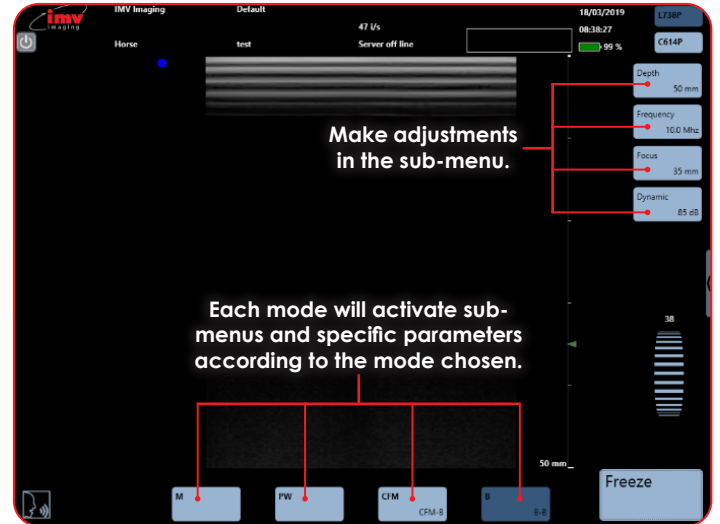

2.4 Choice of probes

ExaPad has two probe connectors located at the back of the scanner.

The first connector from the top of the scanner corresponds to the probe displayed in the top of the screen.

The second connector from the top of the scanner corresponds to the second probe displayed.

N.B: The ExaPad Mini has only one probe connector.

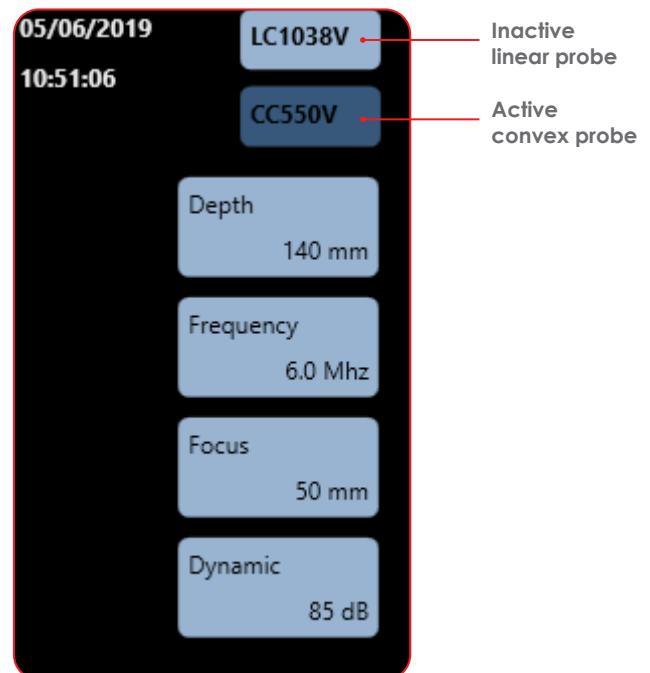

3. Settings

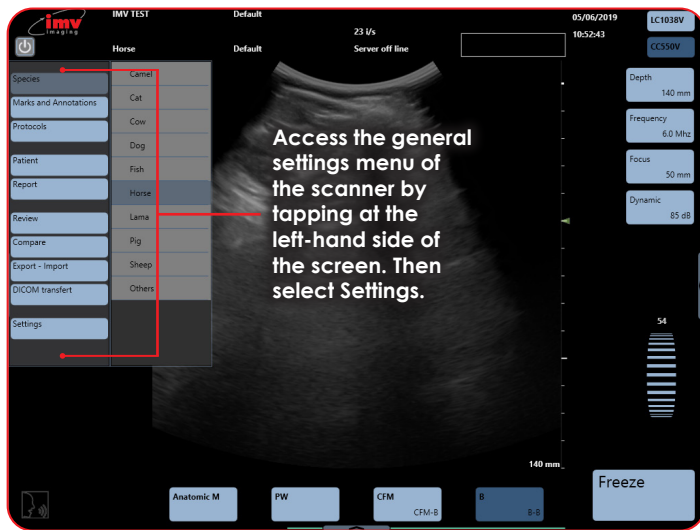

The Settings menu gives access to the configuration of the following menus and sub-menus;

3.1 User Menu

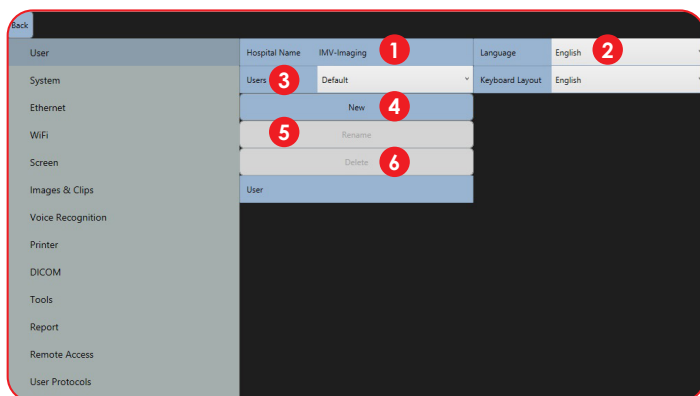

- 1 **Hospital Name:** Enter the hospital or clinic name.
- 2 **Language:** Choice of language for the interface and keyboard.
- 3 **Users:** Selection of a user name.
- 4 **New:** Create a new user who can have individual presets. Go to the Field User and type the users name. Confirm by clicking Enter on the keyboard.
- 5 **Rename:** Select a user in the drop-down menu, click on Rename and Confirm change by clicking Enter on the keyboard.
- 6 **Delete:** Select the user in the drop-down menu, click Delete and confirm by clicking OK in the pop-up window.

Each user will have its own presets, the creation of a new user will reset all presets for the new user as well as all connectivity options.

3.2 Mandatory Patient Record

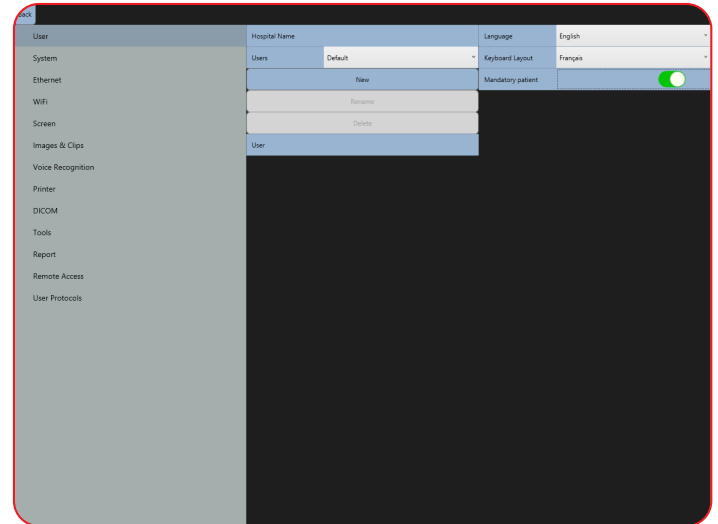

The "Mandatory patient" option should be checked in Settings / User.

When this option is active:

Animal ID becomes a required field.

Images and clips are saved only if a patient is existing, and an exam is in progress.

If there is no exam in progress while saving an image or clip, a message appears:

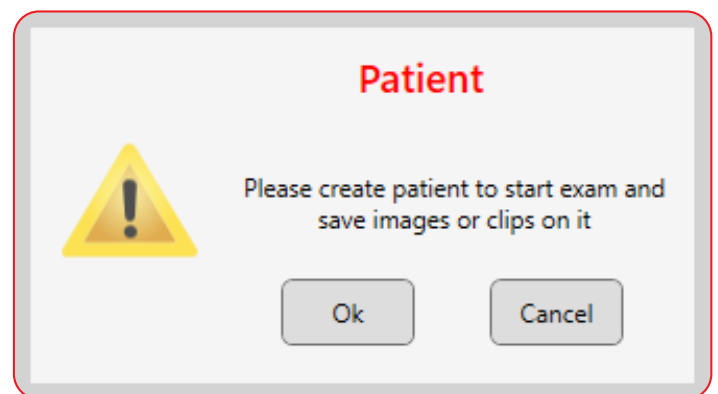

Please create patient to start exam and save images or clips on it : " - ok or cancel

If user presses "ok", they are redirected to the patient page to create a patient and start an exam. The image is saved inside the exam once the patient is created.

If user presses "Cancel", it stays in scanning mode, but the image is not saved into the memory of the system and will not be retrievable at a later date.

3. Settings

3.3 System Menu

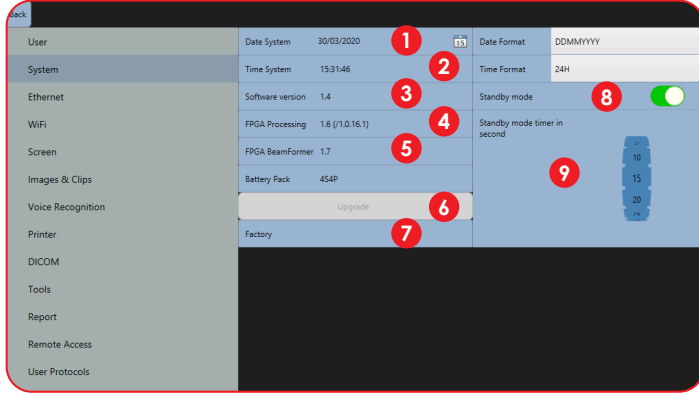

- 1 **Date System:** Adjustment of date. Date formats: DDMMYYYY, MMDDYYYY or YYYYMMJJ.
- 2 **Time System:** 12 or 24 hour clock.
- 3 **Software Version:** current installed ExaPad software version.
- 4 **FPGA Processing:** FPGA board version.
- 5 **FPGA Beamformer:** Beamformer version.
- 6 **Upgrade:** Software upgrade when a USB flash drive with update is connected to scanner.
- 7 **Factory:** Accessible only by IMV imaging.
- 8 **Standby Mode:** Allows the user to save battery time by turning on the Standby mode. Screen brightness is dimmed and frame rate lowered as soon as the probe is in the air.
- 9 **Timer:** Set the time in seconds before the standby mode starts.

NB: Standby mode inactive when scanner plugged in to the electricity.

3.4 Ethernet Menu



- 1 **DHCP:** Activation/deactivation of the DHCP.
- 2 **MAC Address:** Display of Ethernet MAC (Media Access Control) address.
- 3 **IP Address:** IP address of the scanner.
- 4 **Netmask:** Address of netmask.
- 5 **Gateway:** Address of gateway.

Modify: If you are not in DHCP, you can set IP address manually, with its Netmask and Gateway.

3.5 Wi-Fi Menu

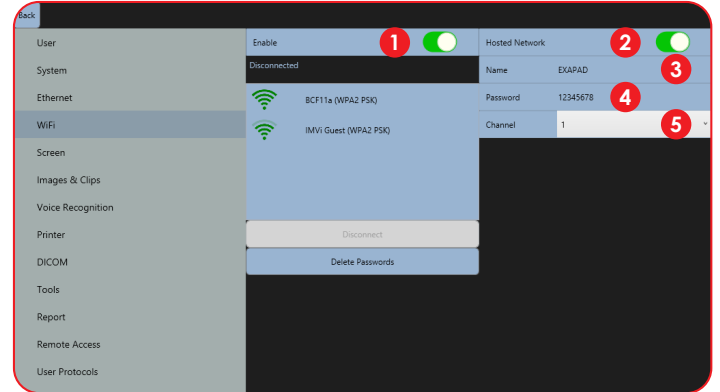

- 1 **Enable:** Activation/deactivation of the Wi-Fi to see available networks.
- 2 **Hosted Network:** Activation/deactivation of the ExaPad's hotspot used to connect an iPad to the scanner.
- 3 **Name:** Name of ExaPad's hotspot.
- 4 **Password:** Password for ExaPad's Hotspot.
- 5 **Channel:** Selection of the Wi-Fi channel (choose the least used channel to get a better frame rate on the iPad).

Saved Wi-Fi networks will be marked with a star.

3.6 Screen menu



- 1 **Landscape:** If disabled, screen is in Portrait mode.
- 2 **Mode Menu Sequencing:** The order of how imaging modes are displayed on main screen can be changed using up and down buttons.
- 3 **Reduced Image:** Reduce the size of B image for better definition. (This mode is only available in Landscape imaging - mode not saved in presets).
- 4 **Full Sector:** Allows you to see the full ultrasound images without cutting off the edges (convex probes only).
- 5 **Close Menu After:** Set time to close menu on left and right side of the screen (5 to 15 seconds).

3.7 Image & Clips Menu

As default, images and clips are saved as raw data.

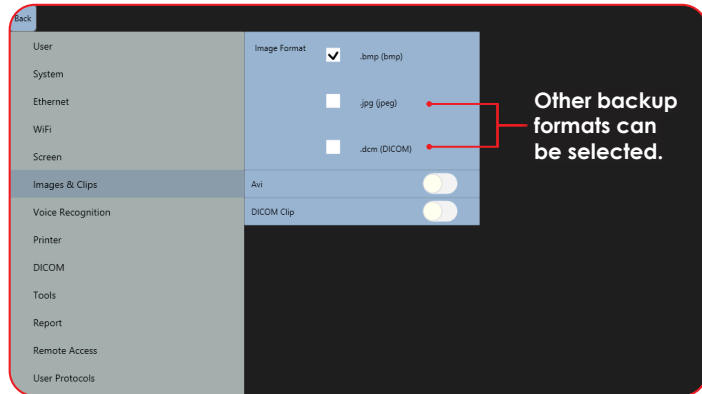

3.8 Voice recognition

Commands are only available for B-Mode. The list of commands are displayed in the selected language.

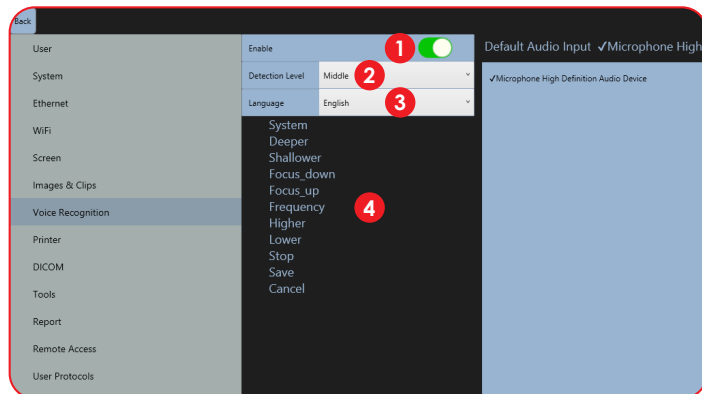

- 1 **Enable:** activation of voice control.
- 2 **Detection Level:** detection filter level.
- 3 **Language:** choice of language for voice control.
- 4 **List of Words:** List of commands.

3.9 Printer

Connect a printer using the USB port on the side of the machine.

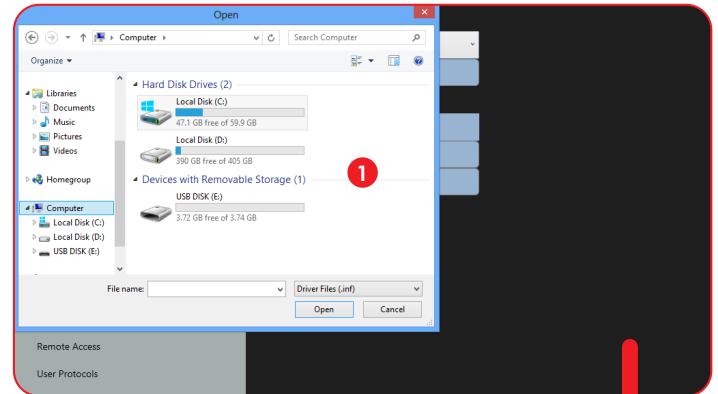

- 1 **Select Driver:** enables the driver selection for the installation of a new printer. Before installing a new printer, press "Select driver" and a new window opens. Search the hard disk or an external support for the driver of the printer to be installed and follow the installation procedure.

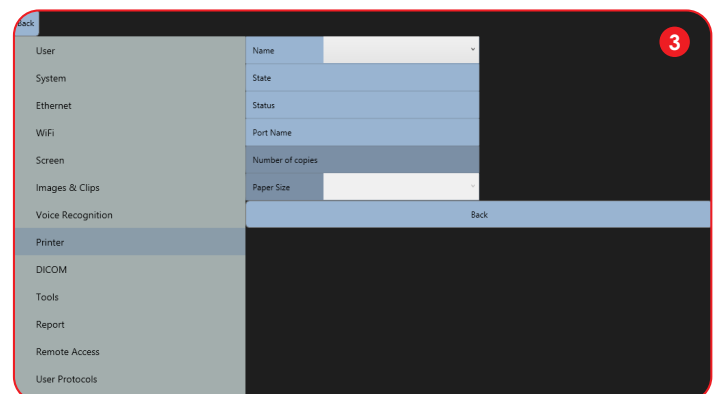

- 2 **Default Printer:** Selection of default printer when several printers are connected.
- 3 **Printer Settings:** Access to the settings of the printer and printing parameters.
- 4 **Install Printer:** Adding of a printer with the use of the printer driver.

3. Settings

3.10 DICOM

In order to be used, the DICOM store and DICOM print must be correctly configured with the information obtained from the DICOM administrator in the premises (clinic/hospital).

Enable DICOM store to send images and clips to the server during and at the end of an exam. Connection parameters must be entered correctly otherwise images and clips will be stored locally.

When DICOM Print is activated, images are printed through the printer server.

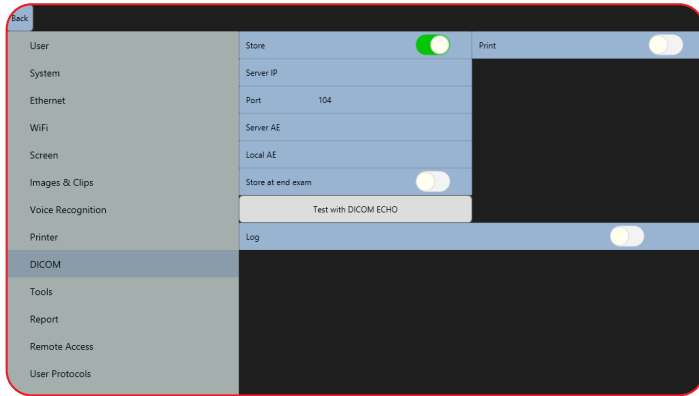

3.11 Tools

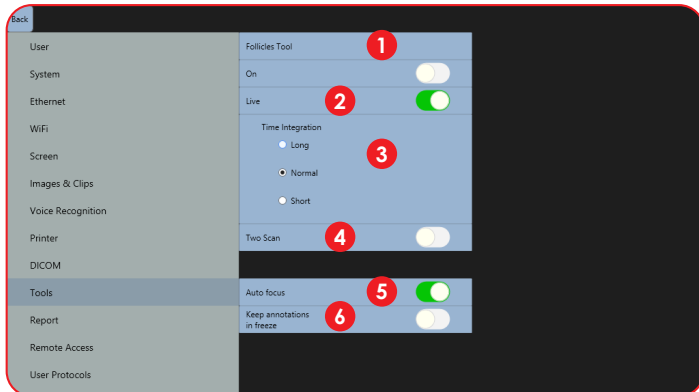

- 1 **Follicle Tool:** Enables the automatic follicle measurement tool. After activation, a shortcut will appear in bottom right of screen to deactivate follicle calculation.
- 2 **Live:** When enabled, follicle measurement can be done when live scanning. If disabled, follicle measurement can only be done in freeze mode.
- 3 **Time Integration:** Select Long for slow scanning movement
Select Short for fast scanning movement (measurement less precise).
- 4 **Two Scan:** enables the automatic measurement of two follicles at the same time on the B Image.
- 5 **Auto Focus:** If activated, focus and frequency will change automatically upon depth adjustments.
- 6 **Keep Annotations in Freeze:** When enabled, annotations will re-appear in "Freeze". Annotation will disappear when the imaging mode changes, when deleted or when this function is disabled.

3.12 Report

The Report function incorporates the measurement RVD (Right ventricle diameter) within the cardio package.

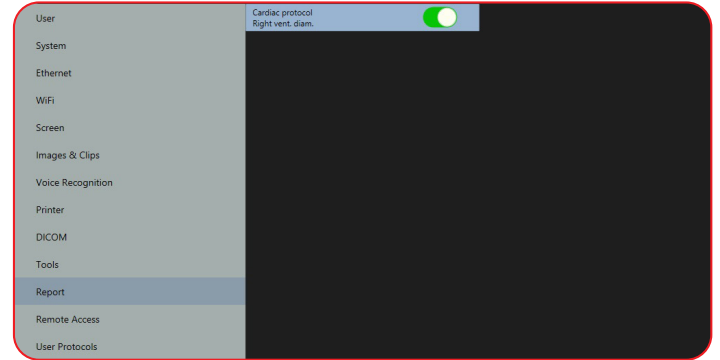

3.13 Pregnancy Tables, days or weeks

It is possible for the user to select between weeks + days or Days only for the duration of a pregnancy.

This setting cannot be changed during an exam.

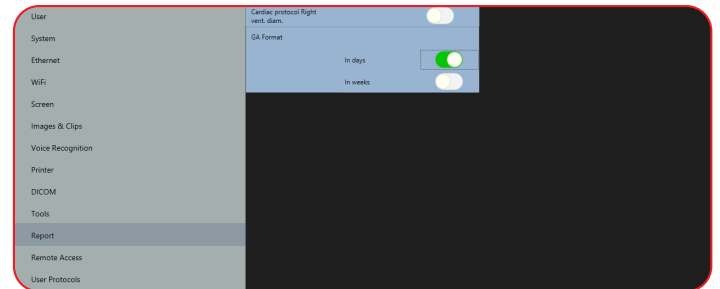

3.14 Remote Access

Remote access for ExaPad, select "Display" to access (internet connection is required).

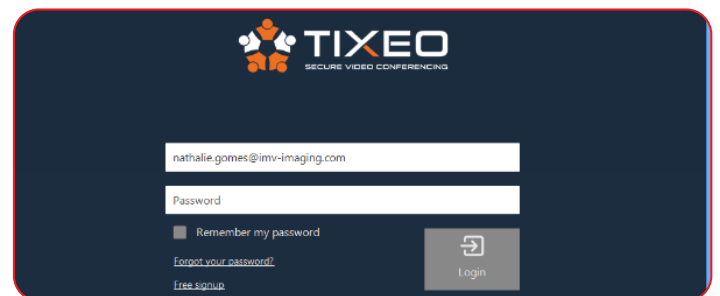

Enter email & password.

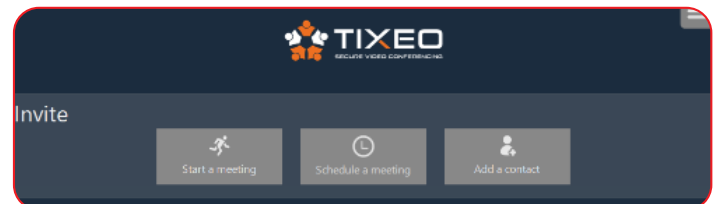

*For more information, please refer to Pg 37 19.1 Remote access login procedure.

3.15 User Protocol

User Protocols allow you to create specific measurements to be carried out for each specie you are scanning.

Decide what measurements and tables should be used by creating a User Protocol.

First select the specie for which you are creating the Protocol, then select an application from the list. For each application, select the measurements needed. Give the Protocol a title in the User Protocol Name box and save.

Delete as necessary.

To select a Protocol while scanning, see section 16 (Protocols: Page 33).

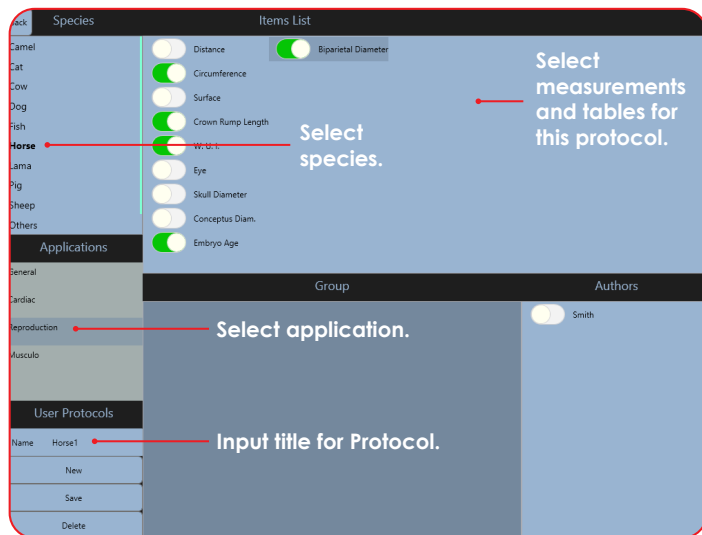

3.16 User Measurement Protocols

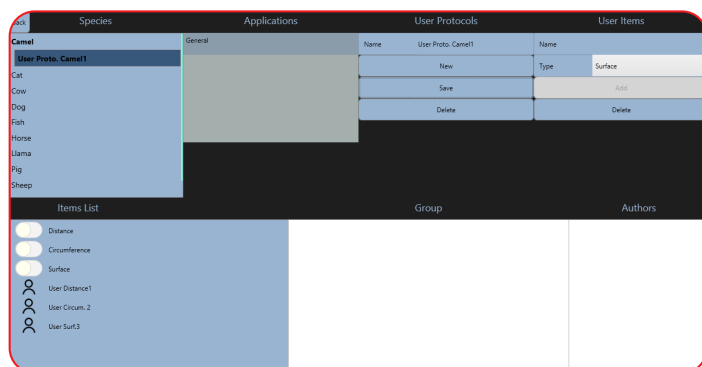

It is now possible to add items to the user protocols. (Surface, Distance, Circumference, Area, Elliptic Volume and Trance Area)

Type the name of your item in the top right corner box, select the type of measurement and press Add. The item gets added to the list.

4. B-Mode Imaging

The B-Mode is the basis for other available modes.

When using one of the combined modes, you can return to the B-Mode by pressing the button "B" found on the bottom menu.

The main adjustment parameters for the B-mode are always displayed on the screen and gives quick access.

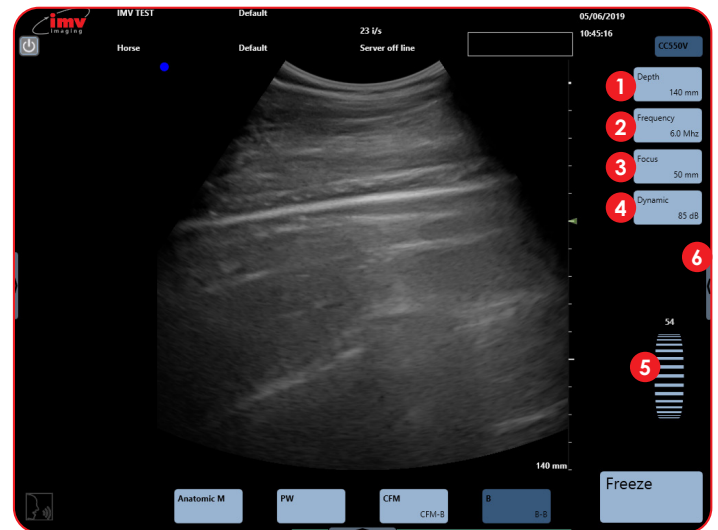

- 1 **Depth:** Increase and decrease of the examination depth by pressing the button "Depth". Maximum depth varies by probe. Updated Depth is displayed on depth button.
- 2 **Frequency:** Each probe has three frequency settings within its bandwidth. The updated frequency is displayed on the frequency button.
- 3 **Focus:** The position of the focal point on screen is adjusted by the "Focus" button. The updated position of focus is displayed on the focus button.
- 4 **Dynamic:** Increase and decrease dynamic range. The updated range is displayed on the Dynamic button.
- 5 **Gain:** Scroll up and down to adjust gain. Gain units go from 1-100 and is displayed above the gain scroller.
- 6 **Advanced Adjustment Menu:** The advanced adjustment menu is accessible when pressing on the arrow button on the right side of the screen.

4. B-Mode Imaging

4.1 Time Gain Compensation

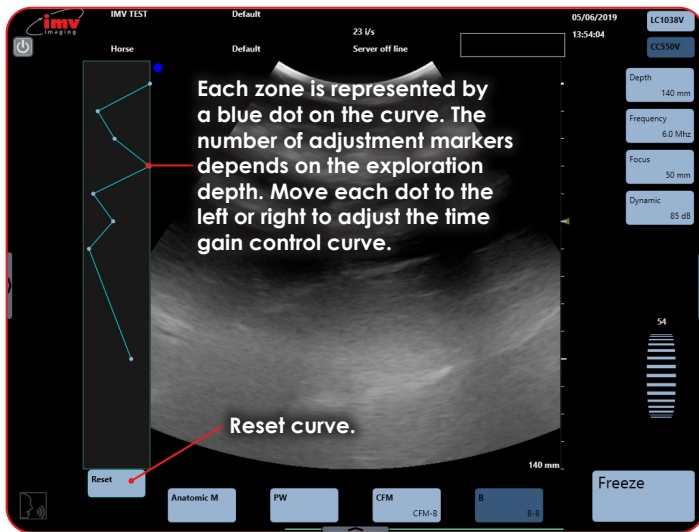
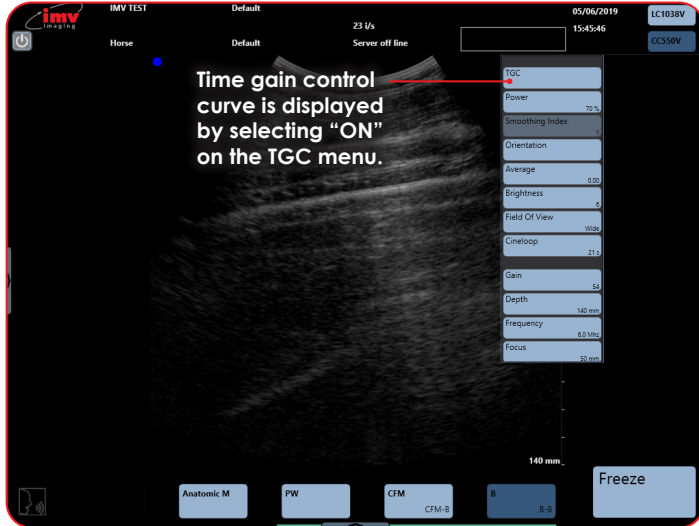

4.2 Other Advanced Adjustments

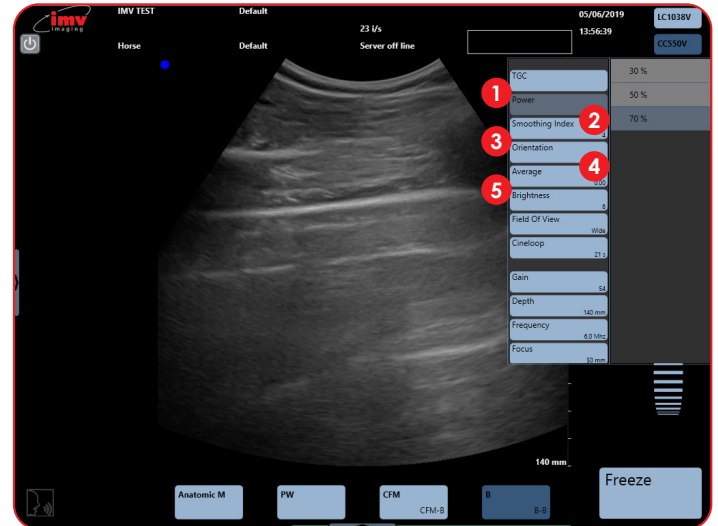

- 1 **Power:** Emission power adjustment choose between 30, 50, 70 and 100%.
- 2 **Smooth:** Activation or deactivation of Smooth index. The smaller the index value, the smoother the image. A higher index value will give a harder image.
- 3 **Orientation:** Turn the image up, down, left or right. Rotate 90°, 180° or 270°. Reset to return to standard parameters.
- 4 **Average:** Time average or temporal smoothing adjustment.
- 5 **Brightness:** Adjust brightness of screen.
- 6 **Field of View:** Adjust the width of the image to regain the frame rate.
- 7 **Cineloop:** Adjust cineloop length, the longer the cineloop the lower the resolution (See page 17).

4.3 Dual Imaging

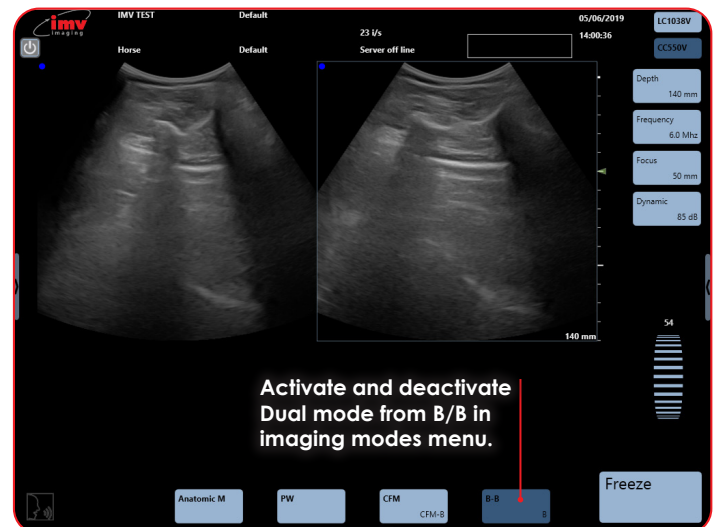



The image on the right of the screen is live. Touch the left image in order to freeze the first image and activate the second.



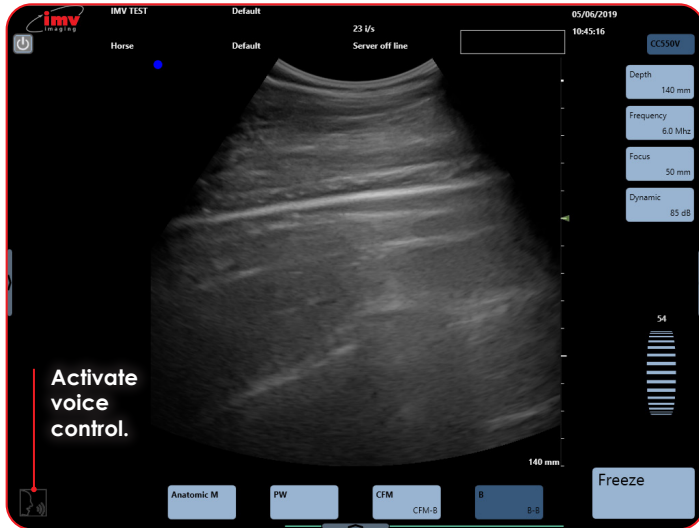

When the two images are both frozen, the image that will be live when pressing "Freeze" is the image with a blue box around the image. A cineloop is available on the latest sequence of images.

4.4 Voice Command



The voice control has three different states:

- : The voice control is not active
- : The voice control is activated and ExaPad waits for an order
- : ExaPad listens to you

Activate the voice control, this pictogram  flashes a few times before it replaces the pictogram . Start by pronouncing "System" to instruct the ExaPad to listen. Wait until the pictogram  is displayed. Pronounce the desired voice control. When the pictogram  flashes and is displayed again, a new request can be pronounced.

Start all voice controls by pronouncing "System"

The following controls are available for voice control:

- **Deeper:** Increase of exploration depth
- **Shallower:** Decrease of exploration depth
- **Focus Down:** Deeper Focus
- **Focus Up:** More superficial Focus
- **Frequency:** Passing from one frequency to another, circular
- **Higher:** Increase of general gain in B-Mode (steps of 10 units)
- **Lower:** Decrease of general gain in B-Mode (steps of 10 units)
- **Stop:** Freeze and unfreeze of image
- **Save:** Storing of current image
- **Cancel:** Cancelling of the last processed voice control

French and Spanish controls are also available, contact us to find out more on info@imv-imaging.com or +44 (0)1506 460023

5. CFM-Mode Imaging

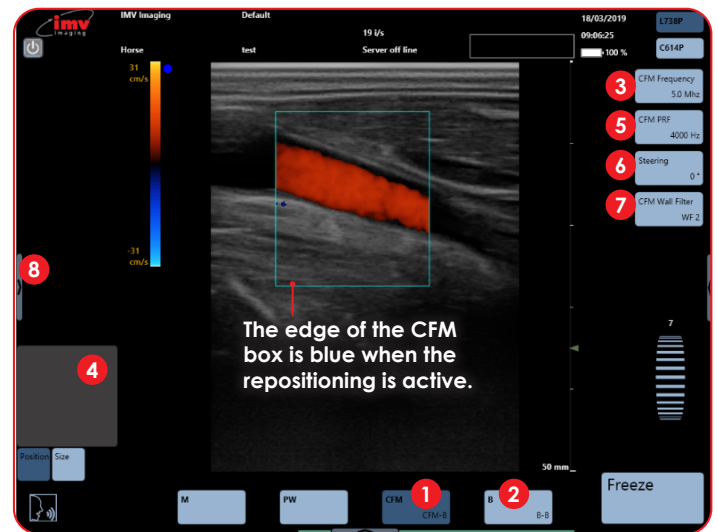

The colour scale which is also the PRF scale is graduated in two parts in order to distinguish the two directions of the flows: towards and away from the probe. Slow flows are depicted in dark red or dark blue; high speeds are passing from blue to white or from red to yellow (depending on the direction).

- 1 **CFM:** Activation of Colour Flow Mapping added to B image.
- 2 **B:** Deactivation of CFM-Mode.
- 3 **CFM Frequency:** Adjust CFM Frequency.
- 4 **Position Box:** Adjust position or size of CFM box. To adjust size, slide from left to right to enlarge and decrease horizontally and up and down to enlarge and decrease vertically.
- 5 **PRF:** Adjust Pulse Repetition Frequency in CFM. Updated PRF value in Hz is displayed and the PRF colour scale in cm/s is updated on the left of screen.
- 6 **Steering:** The CFM box can be steered using Steering. Only possible using the linear probe.
- 7 **Wall Filter:** This filter is filtering low frequencies linked to vascular wall movements and not flows. The higher the filter, the more the low frequencies of circular origin will be removed.
- 8 **Advanced Adjustments Menu:** Access the advanced adjustments menu by tapping at the left-hand side of the screen.

5. CFM-Mode Imaging

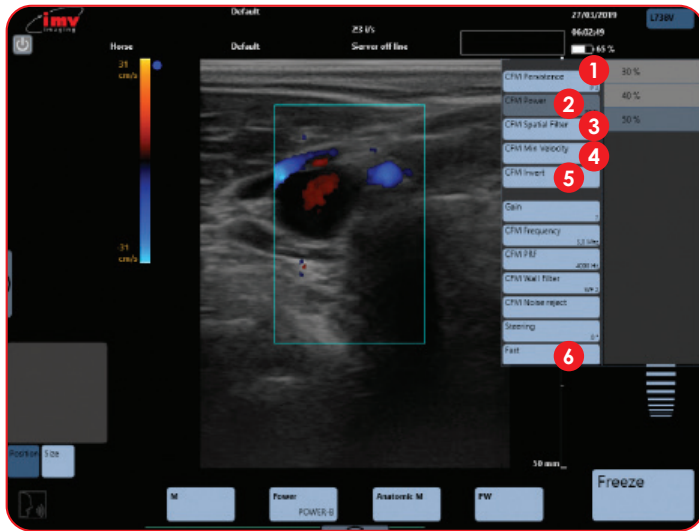

- 1 **Persistence:** Adjust persistence.
- 2 **Power:** Adjustment of emission power in CFM.
- 3 **Spatial Filter:** This filter smooths the colour Doppler.
- 4 **Min Velocity:** The CFM velocity is on when CFM is activated. This function defines minimum visible velocity.
- 5 **Invert:** Inversion of the colours in CFM.
- 6 **Fast:** Activation of fast will increase the frame rate. Deactivation increases resolution.

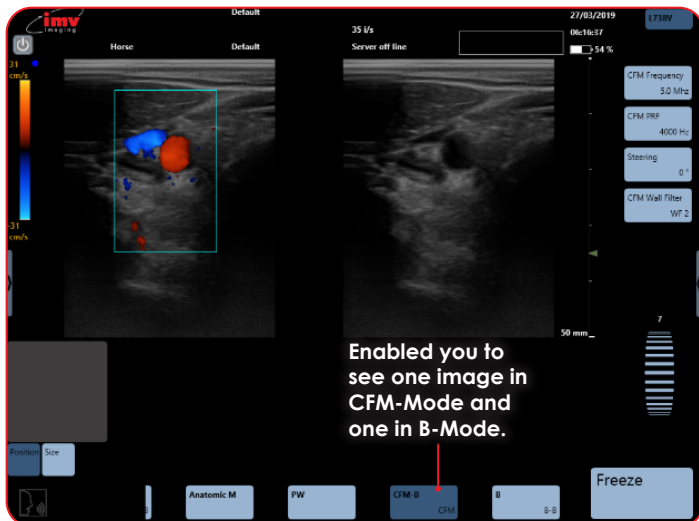

6. PW Doppler Mode Imaging

6.1 Position and size of the PW gate

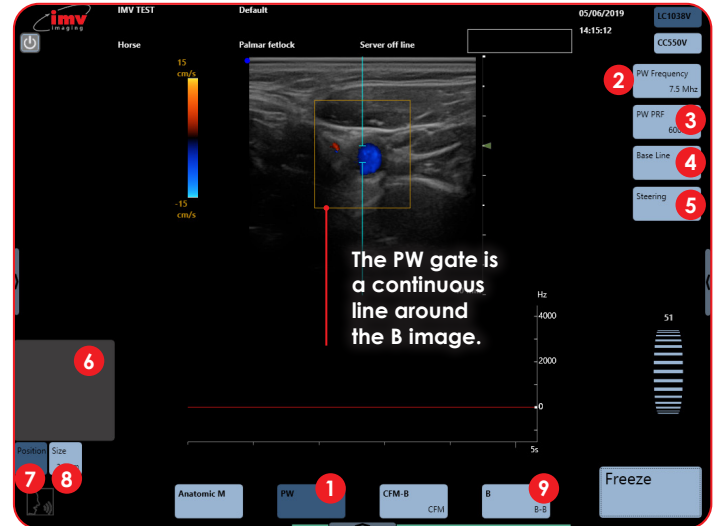

- 1 **PW:** Start PW imaging. Activate Pulse Wave, PW specter is added to the B image.
- 2 **Frequency:** Adjust PW frequency.
- 3 **PRF:** Adjust Pulse Repetition Frequency. Updated PRF value in Hz is displayed in the PRF button on the screen.
- 4 **Base Line:** Adjust PW spectrum base line.
- 5 **Steering:** Adjust the angle of the PW gate.
- 6 **Position Box:** Track pad.
- 7 **Position:** As soon as you position the PW gate on the desired area, the PW specter will start running.
- 8 **Size:** When activated, the track pad will resize the PW gate. Slide up to increase size and down to decrease.
- 9 **B:** Deactivate Pulse wave and return to B-Mode.

Access the advance adjustments menu by tapping at the right-hand side of screen.

7. CW Doppler Mode Imaging

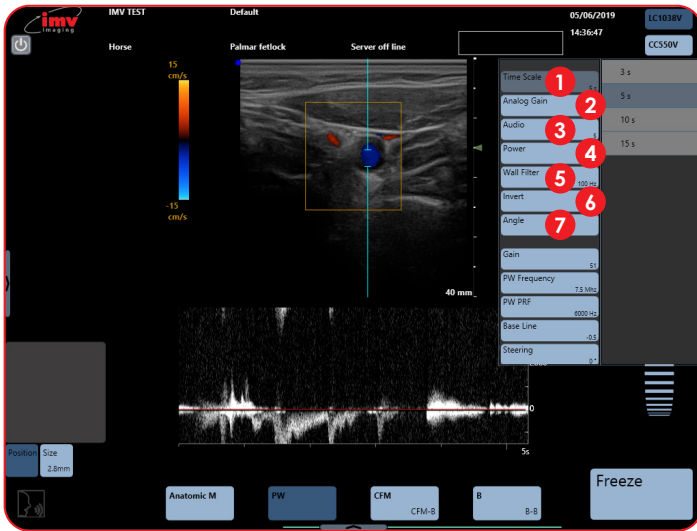

- 1 **Time Scale:** Adjust PW Time scale.
- 2 **Analog Gain:** Adjust analog gain for PW. Different scale from general gain which is digital gain.
- 3 **Audio:** Adjust audio level.
- 4 **Power:** Adjust PW power.
- 5 **Wall Filter:** Adjust wall filter. This filter is filtering low frequencies linked to vascular wall movements.
- 6 **Invert:** Spectrum inversion, the display of the PW Spectrum can be inverted.
- 7 **Angle:** The angle made by the Doppler firing and the measured flow is activated in the advanced adjustment menu.

When Angle is activated, the angle is displayed on the PW gate and the button "Angle" is available under the trackpad on the bottom left of the screen.



Sliding the finger upwards and downwards on the trackpad adjusts the angle in the direction of the flow in order to measure the real speed of the flow.

After modifying the size or the position of the PW gate, press the button "Angle" under the trackpad again in order to activate the angle adjustment.

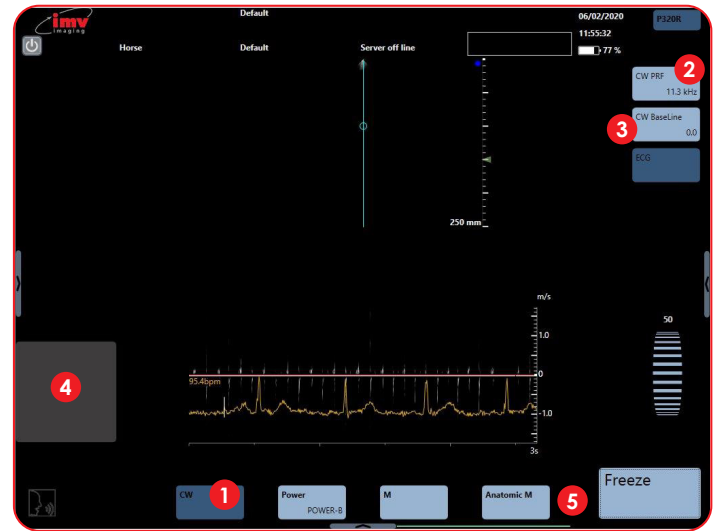

- 1 **CW:** Start CW imaging. Activate Continuous Wave. CW specter is added to the B image.
- 2 **CW PRF:** Adjust Pulse Repetition Frequency. Updated PRF value in Hz is displayed in the PRF button on the screen.
- 3 **CW Baseline:** Adjust CW spectrum base line.
- 4 **Track Pad.**
- 5 **B-Mode Imaging:** Swipe along to return to B-Mode imaging.

Access the advance adjustments menu by tapping at the right-hand side of the screen.

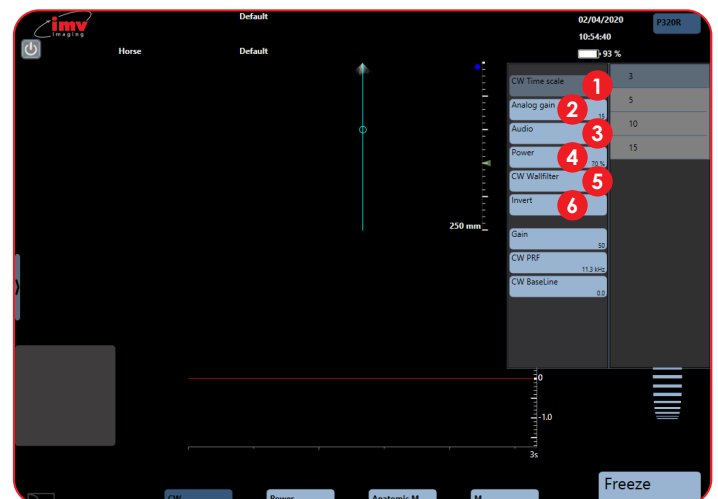

- 1 **CW Time Scale:** Set the time scale of the CW spectrum.
- 2 **Analog Gain:** Adjusts Analog gain for CW, which is a different scale than digital gain.
- 3 **Audio:** Set the sound of the CW Doppler on loud speakers.
- 4 **Power:** Sets the power range of the CW Doppler.
- 5 **CW Wall Filter:** Reduces parasite noises when increased.
- 6 **Invert:** Inverts between positive and negative signal.

8. Power Doppler Mode Imaging

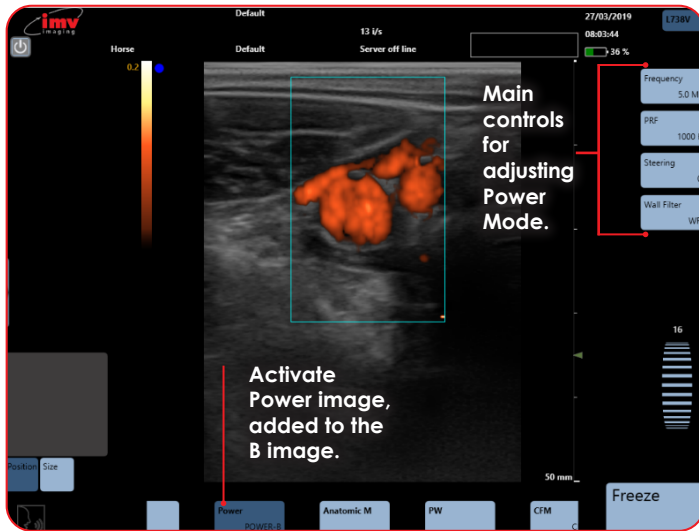

8.1 Position and size of the Power Doppler Box

The Power box can be moved with the trackpad.

To adjust the size, click on the button "Size", situated under the trackpad. The edge of the Power box is a blue dotted line when the size adjustment is active. Slide horizontally on the touch pad to adjust the width and vertically to adjust the height. After adjusting the size of the Power box, the active adjustment automatically returns to the positioning of the box after a short lapse of time.

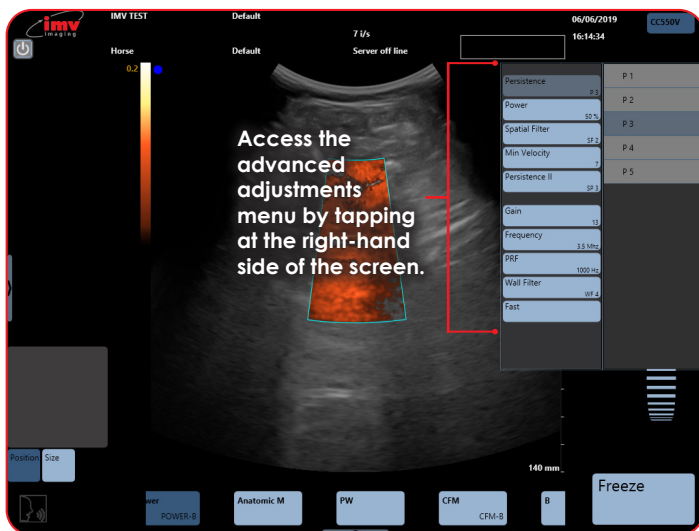

8.2 Dual Power Doppler

- 1 Power/Power B:** Activation and deactivation of the function Dual Power Doppler by clicking on the button Power/ Power-B.

The function Dual Power Doppler enables to visualise the same live image simultaneously in two different modes, one in Power Doppler mode and one in B-Mode.

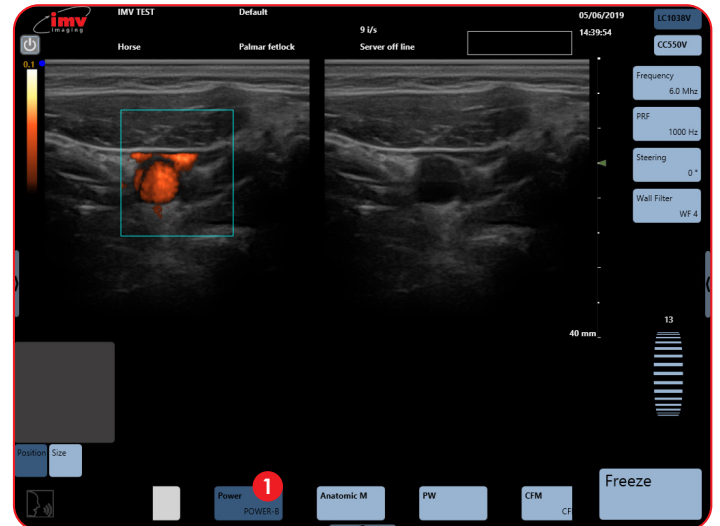

9. M-Mode Imaging

- M-Mode:** To activate M-Mode imaging by sliding along on the lower menu and pressing M. The TM spectrum is added to the B image.

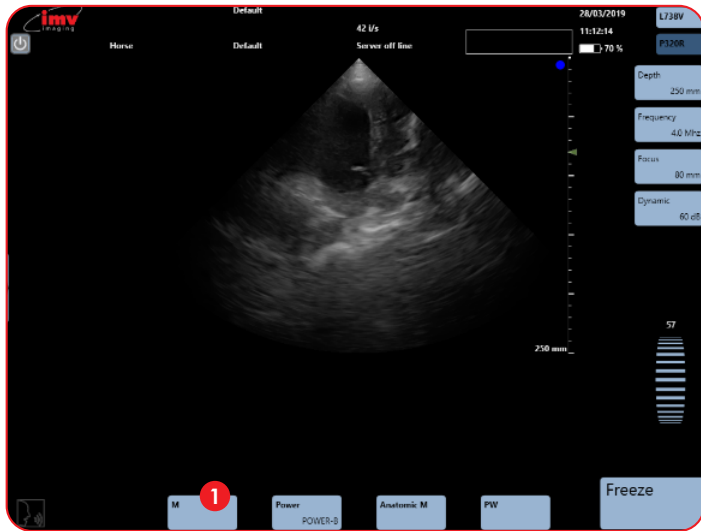

9.1 Position and size of the Anatomic M line

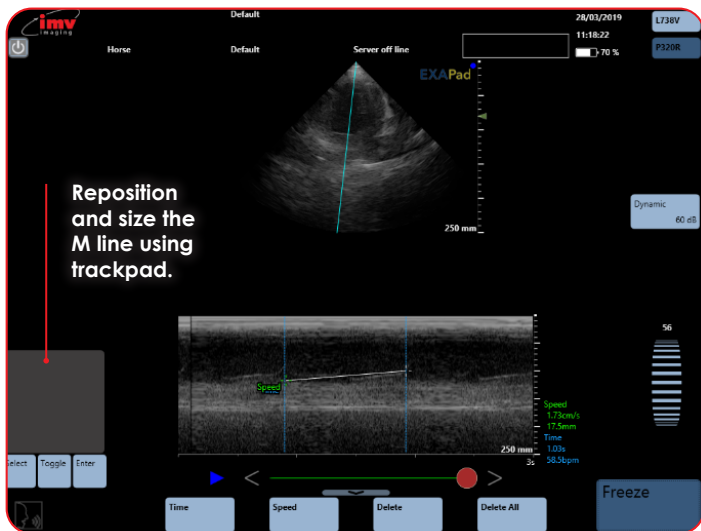

See B-Mode imaging for adjustments available in M-Mode imaging on page 9.

Activation of the Anatomic M-Mode imaging by pressing the button "Anatomic M" from the bottom menu. The Anatomic M specter is added to the B image (B/ anatomic TM).

9.2 Anatomic M-Mode imaging

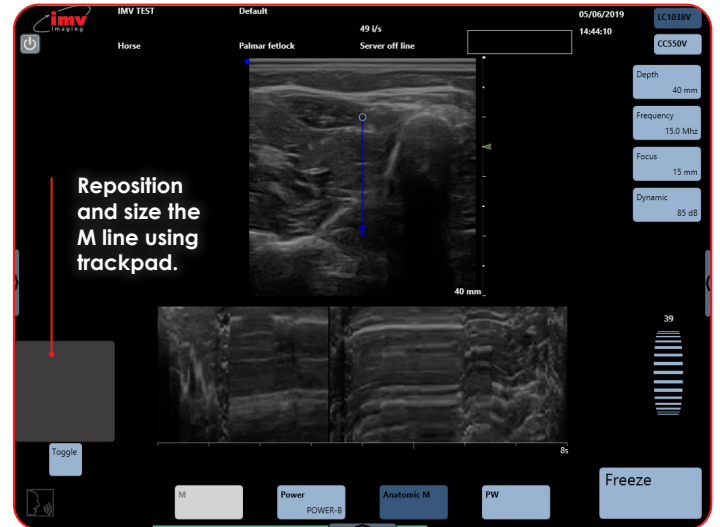

Place the start of the Anatomic M line with the trackpad, then press Toggle in order to position the arrow that symbolises the end of the Anatomic M line specter.

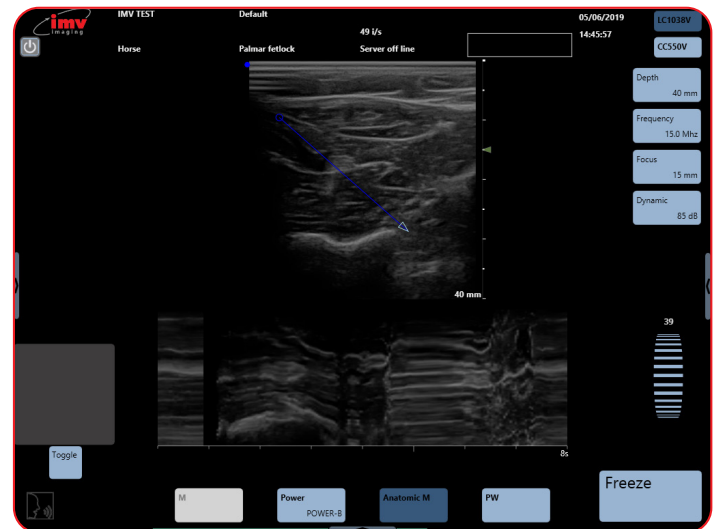

See B-Mode imaging for adjustments available in M-Mode imaging on page 9.

9. M-Mode Imaging

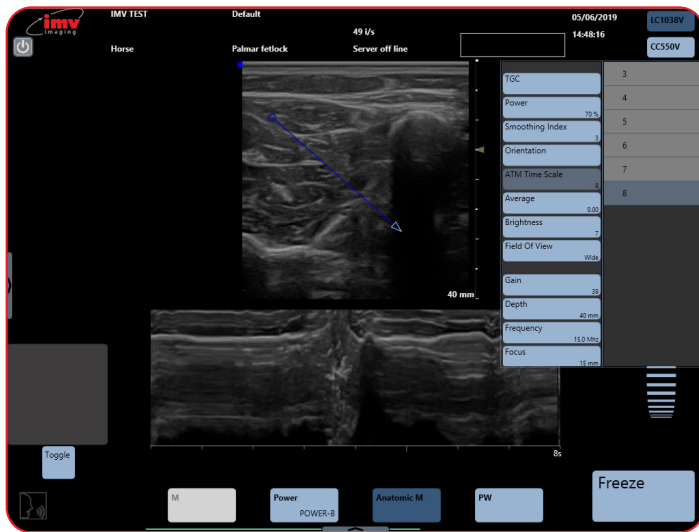

9.3 Time scale in Anatomic TM-Mode

The adjustment of the time scale in Anatomic TM-Mode is made in the advanced adjustment menu, accessed by tapping at the right-hand side of the screen.

10. ECG - Electrocardiogram

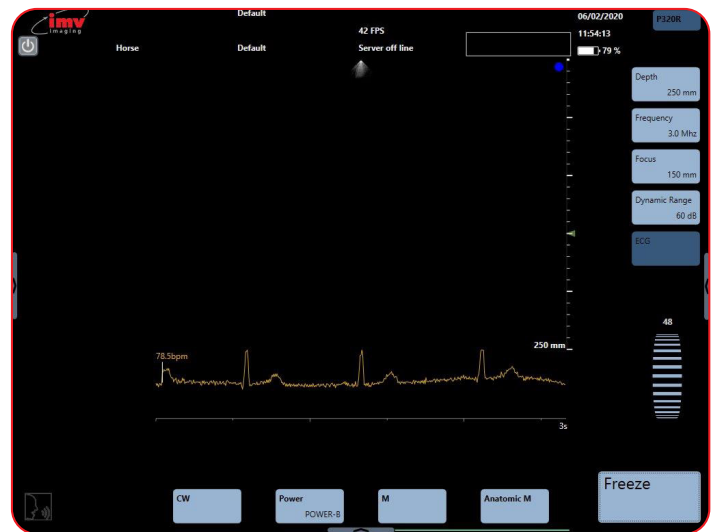

Plug the ECG in the back of the scanner.

Plug a Phased Array probe, the ECG only works with a Phased Array probe.

Go to "measurement protocols" and Choose cardio.

An ECG button will appear just under Dynamic range.

Connect the ECG to the animal respecting the polarities.

Press the ECG button and the ECG will launch.

Adjust scanner settings to your preference as you would for any other imaging mode.

The trace of the ECG will appear just under the Ultrasound image, the heart rate will display just besides the trace.

ECG is available in all imaging modes:

1. Time scale
2. ECG Lead
3. ECG Gain

11. Freeze Mode and Cineloop

11.1 USB Freeze Switch

The USB Freeze switch is a device that allows the user to use a freeze switch on the unit when away from the unit.

The USB Freeze switch is connected to the unit through the USB connector.

When the user presses once on the freeze switch the ultrasound image will freeze on the unit

When the user presses a second time on the USB Freeze switch the ultrasound image will unfreeze

Freeze mode is available in all imaging modes.

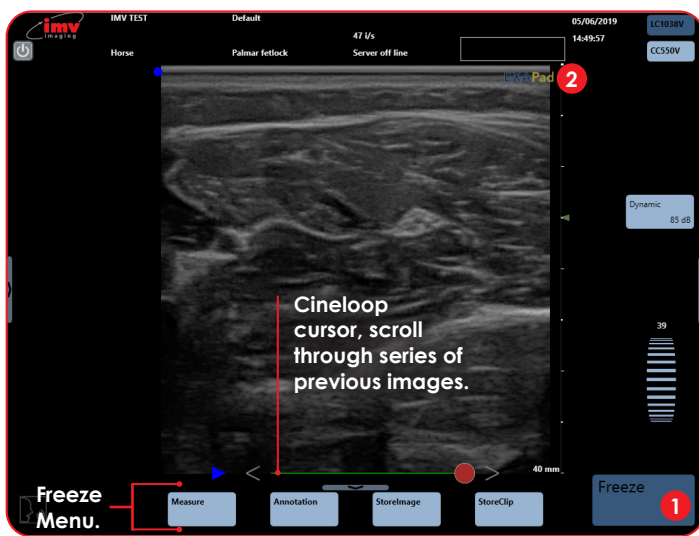

- 1 **Freeze:** Freeze and unfreeze the live ultrasound image.
- 2 **ExaPad:** Indicates that the image is Frozen.

11.2 Cineloop

The length of the sequence depends on the imaging mode and on the frame rate.

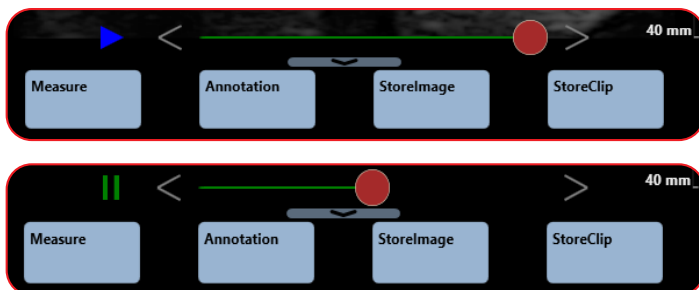

- plays cineloop sequence
- pause cineloop sequence
- previous image in sequence

- next image in sequence

- use to scroll through the sequence of images

It is possible to select the start and the end of the cineloop that should be saved.

Double-click on the red marker (that will be surrounded by a blue line), move the red cursor until the last image in the sequence you want to store.

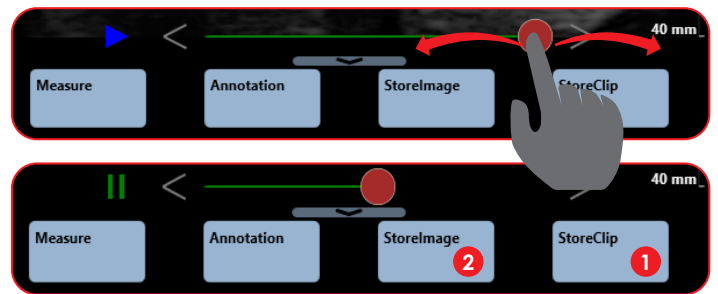

- 1 **Store Clip:** Save the selected sequence.
- 2 **Store Image:** Save selected image.

Images and clips are saved on the hard-disk of the scanner.

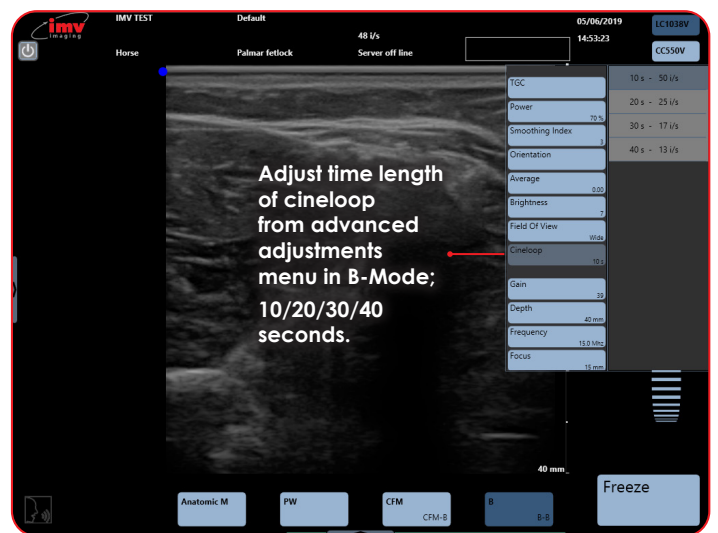

11.3 Post-processing

In Freeze mode, all functions available in post-processing are active.

Post-processing controls are available on cineloop images & sequences as well as on stored images and sequences.

11. Freeze Mode and Cineloop

11.4 Post-processing in B-Mode

The post-processing is made by the advanced adjustment menu in B-Mode.

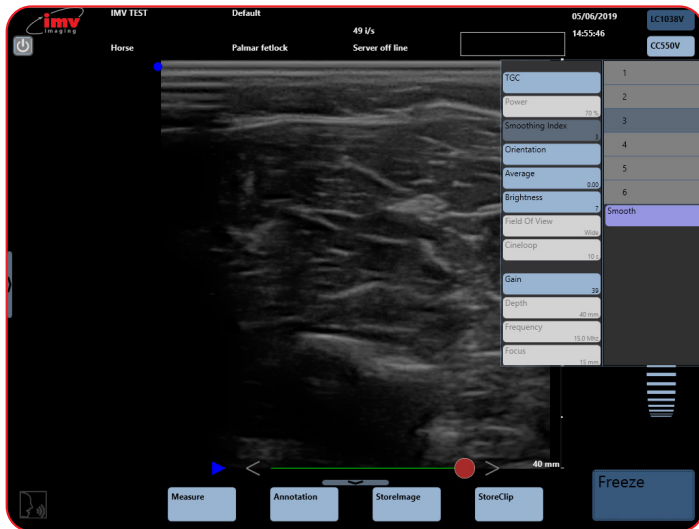

Functions in white are not available for Post-processing.

11.5 Post-processing in CFM-Mode

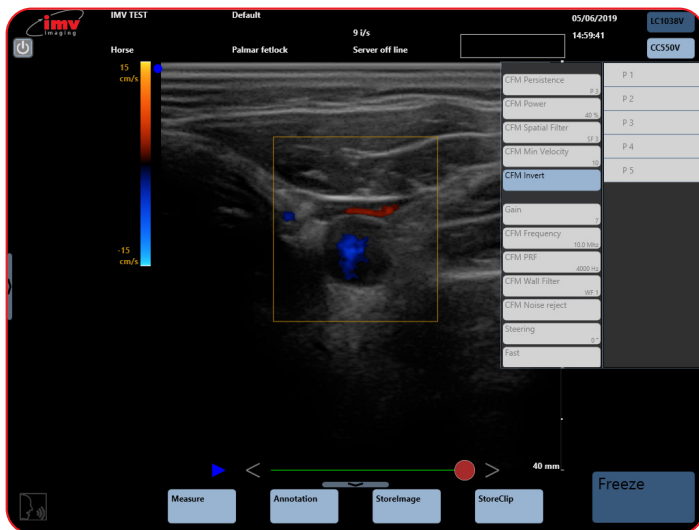

In CFM, only the inversion of colours is available for post-processing.

11.6 Post-processing in PW-Mode

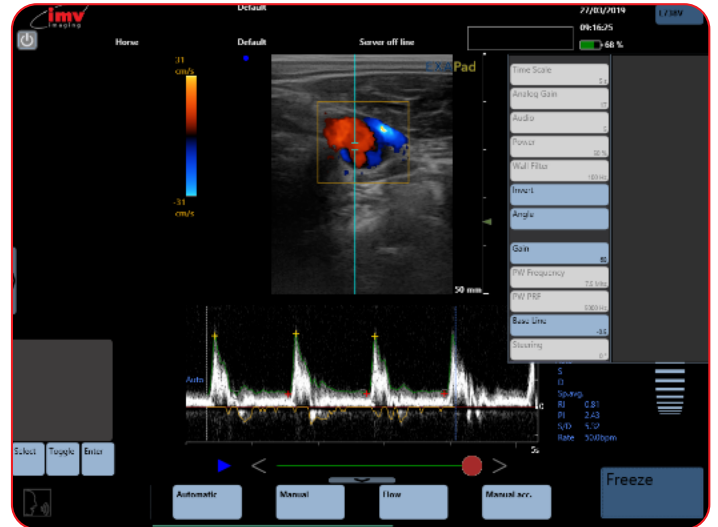

The post-processing is made by the advanced adjustment menu in PW-Mode.

11.7 Post-processing in Anatomic TM-Mode and TM-Mode

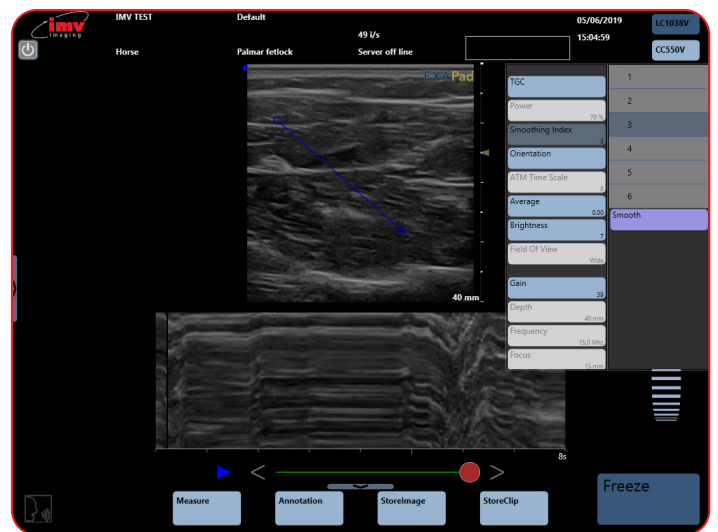

Functions in white are not available for Post-processing.

11.8 Annotations

When the image is frozen, the button "Annotation" is accessible.

It is also possible to enter annotations on a live image or when making measurements as shown below:

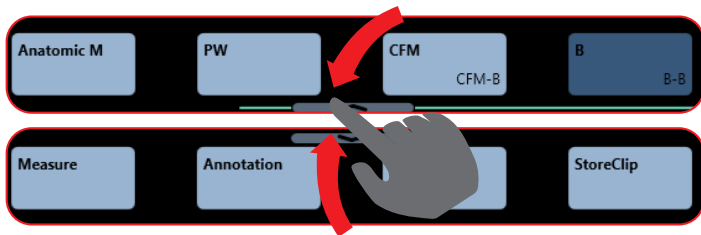

11.9 Entering text

Click on the button "Annotation", place the text box with the trackpad, click on the button "Edit" under the trackpad. This will display a keyboard on the screen. Enter the text and confirm by clicking Enter on the keyboard, or long click on the empty annotation, and a predefined list appears.

The button "Select", under the trackpad, enables you to select a text zone, surrounded by a white rectangle, in order to reposition it and/or modify the entered text by clicking "Edit" again.

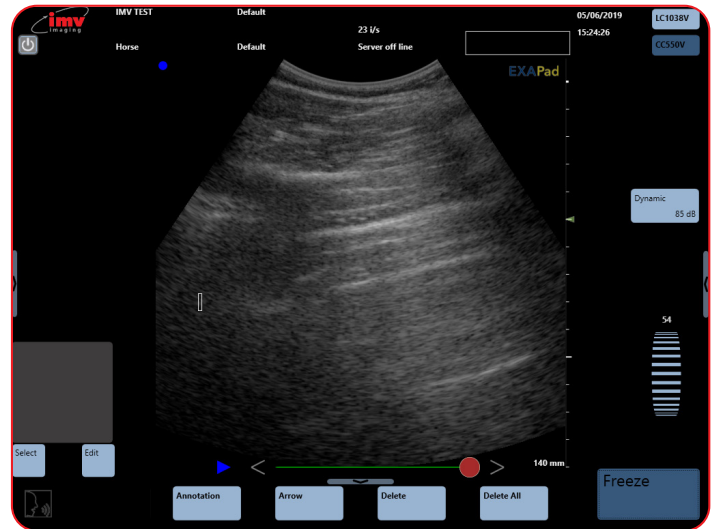
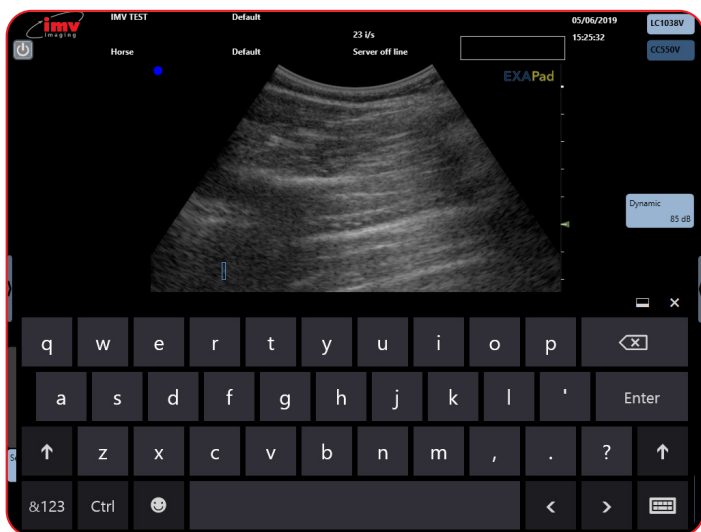

11.10 Annotated arrow

Click on the button "Arrow" on the bottom menu. A caliper is displayed, this will be the tip of the arrow. Place the text zone on the wanted place with the trackpad. "Edit". This will display a keyboard on the screen. Enter the text and confirm by clicking "Enter" on the keyboard.

The button "Select", under the trackpad enables you to select an annotation, the button "Toggle" enables repositioning for either the tip of the arrow or the associated text zone.

11.11 Delete

"Delete" will delete the last entered annotation (text or annotated arrow). "Delete All" will delete all annotations on the screen.

11.12 Marks and annotations

Each image can be tagged with marks or annotations. There are predefined factory marks and annotations. A mark allows the user to define a position on the animal, it will be saved in the image details as a geographical reminder.

A mark is text that will not be deleted from the screen when the image is unfrozen.

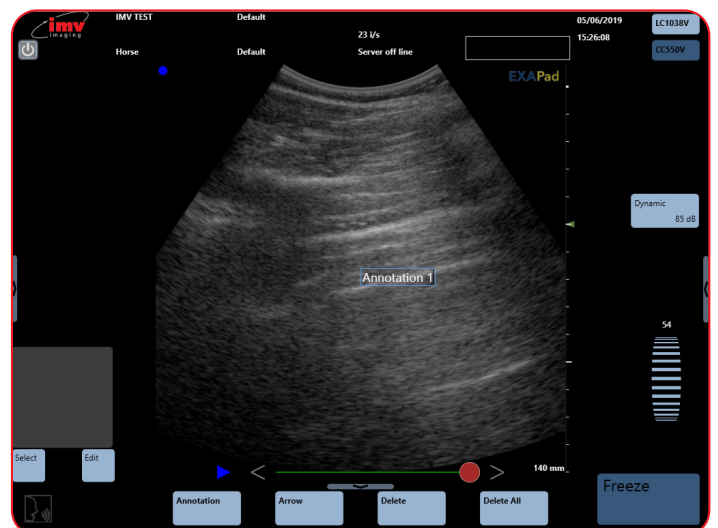

11. Freeze Mode and Cineloop

A user or predefined annotation will be deleted when the image is unfrozen, except if the "keep annotation in freeze" option is activated. in which case the annotation will reappear in Freeze mode. (see settings page 5)

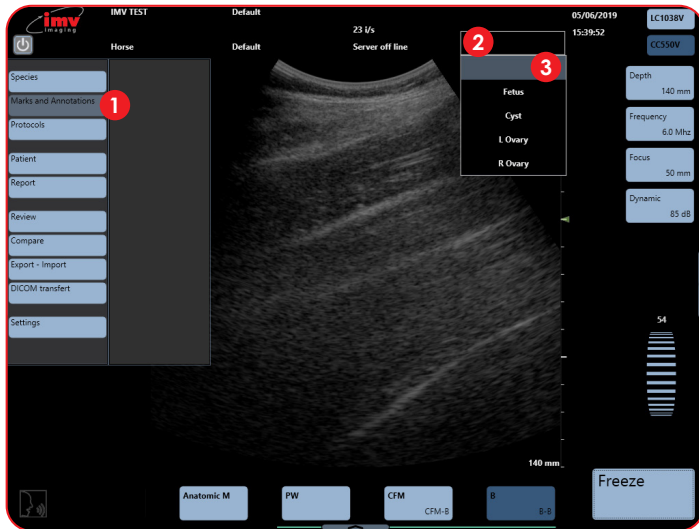

- 1 **Marks And Annotations:** Marks and annotations set up of markers and predefined annotations by tapping on the left hand side of the screen, then choose, "Marks and Annotations".
- 2 **Use Of Predefined Marks:** The marks can be used on live or frozen images.
- 3 Free type text can also be entered as a mark.

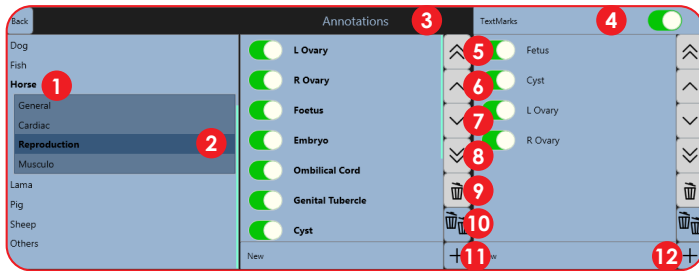

- 1 **Horse:** For each specie and application, you can edit user annotations. Some factory presets will already exist.
- 2 **Reproduction:** Current specie and application are in bold.
- 3 **Annotations:** Predefined list of annotations or marks for current application.
- 4 **Textmarks:** Create predefined Text Marks and put the Text Mark Box at the top of the ultrasound image.
- 5 Places the selected annotation in the first position.
- 6 Places the selected annotation higher.
- 7 Places the selected annotation lower.
- 8 Places the selected annotation in the last position.
- 9 Deletes the selected annotation.
- 10 Deletes all annotations except for the factory exam.
- 11 Enter a new user annotation.
- 12 Validates a new user annotation.

Procedure is identical for Text marks and Annotations

11.12 Predefined annotations

When the image is live, all predefined annotations are deleted from the screen (except if the option "Keep annotation in freeze" is activated in the settings – see Settings-Tools)

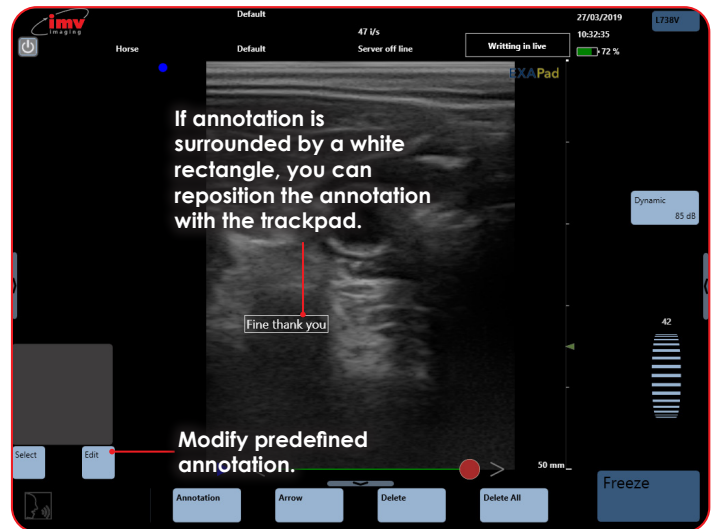
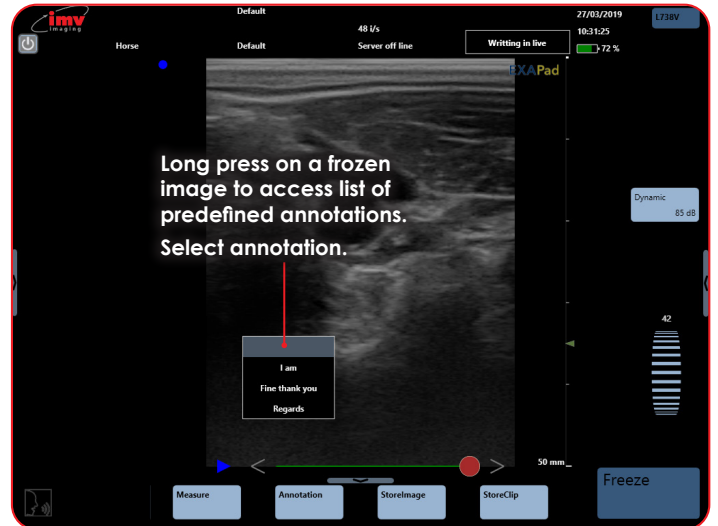

11.13 Text Mark

A text mark entry box exists for each dual image. The entry of text marks is limited to 10 characters. Text marks are displayed on all saved images

12. Storing of Images and Clips, Review

12.1 Storing of images

A frozen image can be stored in the memory of the device by clicking "Store image".

A live image can also be stored in the memory of the device. The button "Store image" will appear underneath the live B menu when clicking here. Press "Store image" to store.

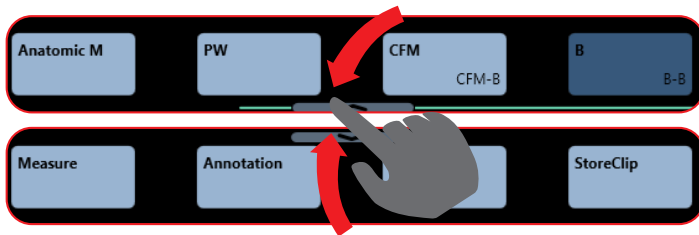

"Store image" is active both in live and Freeze modes.

The selection of storing format (bmp, jpg, dcm) is made in the Setting menu.

By default, the raw data (env) is always stored.

If an image is stored when a patient file is open with "Short scan", the image will be stored in the patient file "Image & clips without report". If a patient file is open in examination, the image will be stored in the report patient file.

If no patient file is open, the image will be stored in the list of unattached images.

12.2 Storing of clips

A frozen sequence can be stored in the memory of the device by clicking "Store clip".

"Store clip" is active in Freeze mode.

By default, the raw data (env) is always stored.

The storing of a clip can also be made in .avi format or DICOM format (DCM) if these formats have been selected in the Setting menu.

If a sequence is stored when a patient file is open with "short scan", the sequence will be stored in the patient file, in examination folder (see Storing Image) or miscellaneous folder.

If no patient file is open, the sequence will be stored in the list of unattached clips.

It is possible to select the time length of the cineloop before saving it in the advanced B adjustment menu (see cineloop). You can also select the area selection of the cineloop that should be saved (see cineloop).

12.3 Filling up the Thumbnail list:

- The thumbnail list appears in Freeze.
- Without a patient, it displays images and clips saved since the boot up of the unit.
- If in "Short scan" mode, it displays images/clips saved since the boot up of the unit for the selected patient.
- If an exam is "in progress", it displays the images/clips of the exam.

12.4 Review

All images and sequences stored in the memory of ExaPad can be reviewed and post-processed.

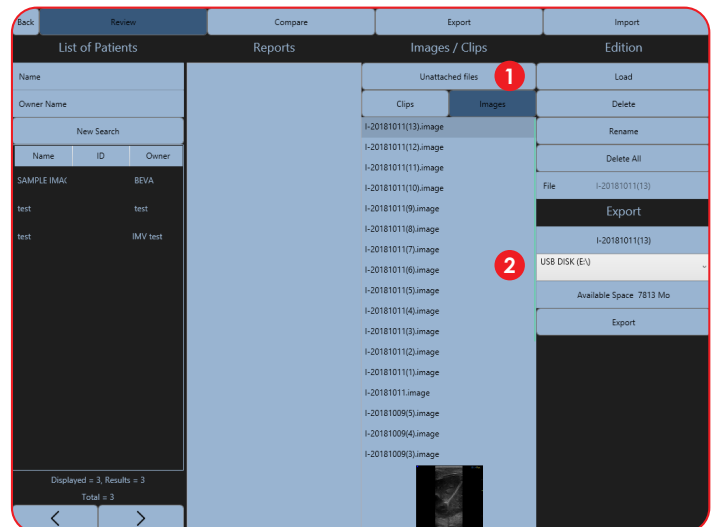
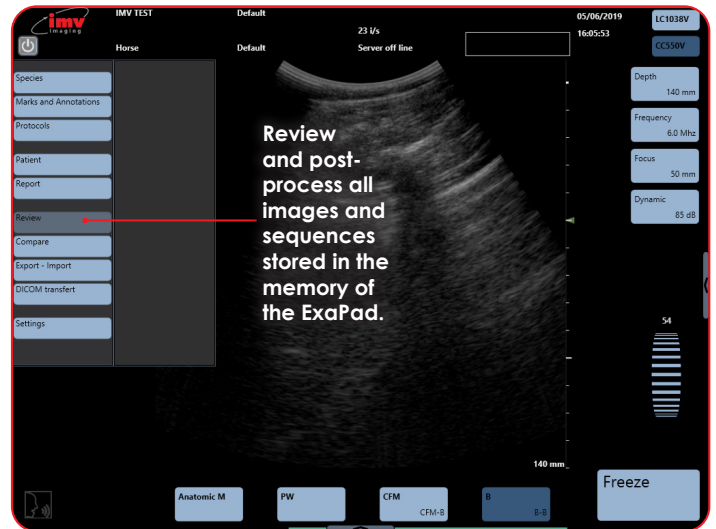

1 Unattached Files: Images saved without a patient folder will be saved here. Click on "Clips" or "Images" to see details.

2 List of Images: The naming convention of the images or cineloops is as follows;

C-26112019(2).cineloop – Cineloop, 2nd clip of day on the 26/11/19

I-26112019(3).image – Image, 3rd image of day on 26/11/19

3 When an image is loaded the list of thumbnails is updated with the list of images from the same folder.

12. Storing of Images and Clips, Review

12.5 Images or clips attached to a patient

When an image or a clip has been stored in a patient folder, search for the requested patient.

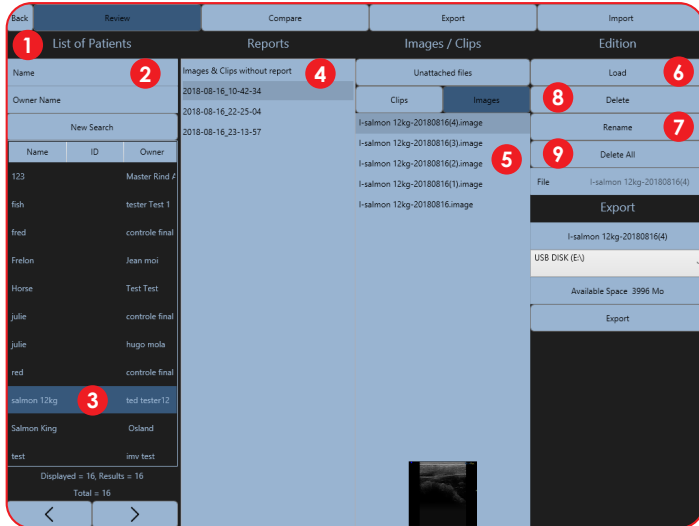

- 1 List of Patients:** Search for a patient in the database by scrolling the patient list. The list is automatically listed alphabetically but can be filtered or searched.
- 2 Name and Owner Name:** Input values to search for a patient.
- 3 Select Patient.**
- 4 Images and Clips Without Report:** Access images and clips without reports or select the report to access images and clips stored within that report.
- 5 Images:** Images and clips attached to patient. The naming convention of the images or cineloops is as follows: I-DURAND-26112019(2).image – Image, day, month and year image was taken, 2nd image of the day, in Durand patient folder.
- 6 Load:** See the image or clip.
- 7 Rename:** The name of file is displayed in the field File. When an image is selected you can rename it. Confirm by pressing "Enter".
- 8 Delete:** When image is selected, press delete to remove it from the system. Press "Ok" to confirm.
- 9 Delete All:** To delete all images and clips in a patient folder, select the patient then press "Delete all". Press "Ok" to confirm delete.

12.6 Loading of images or clips stored during an examination

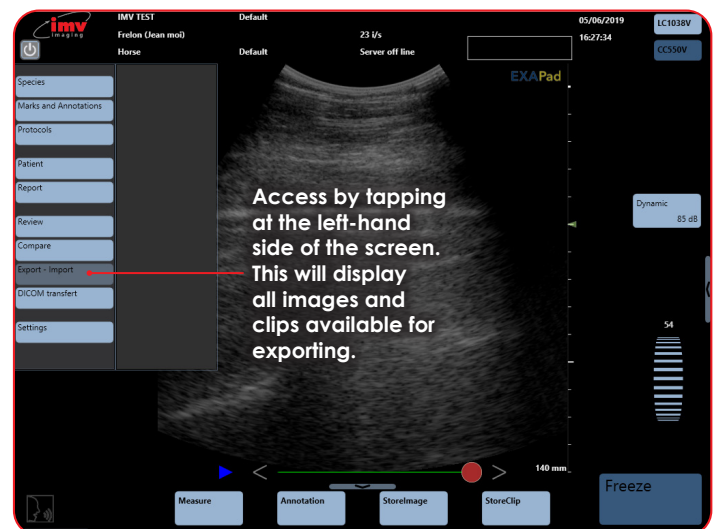
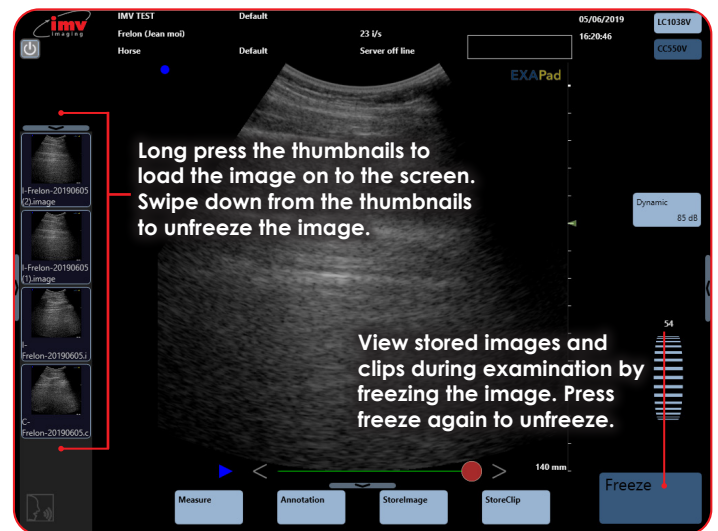
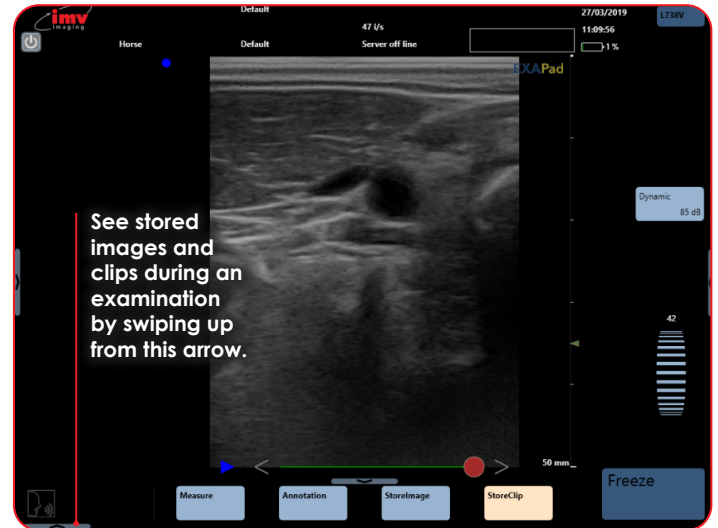

12.7 Exporting a set of images from a report

- 1 Select the patient folder containing the images or clips you want to export.
- 2 Select the report.
- 3 Select "Clips" or "Images".
- 4 Select the images and clips to export, they will then be highlighted in grey.
- 5 Click on the button  to confirm your exports.

The images or clips to export are displayed in the selection section.

- 6 Select the export media.
- 7 Click "Export". The images and clips are exported to the selected media in the formats that have been chosen in the Image menu in Settings.

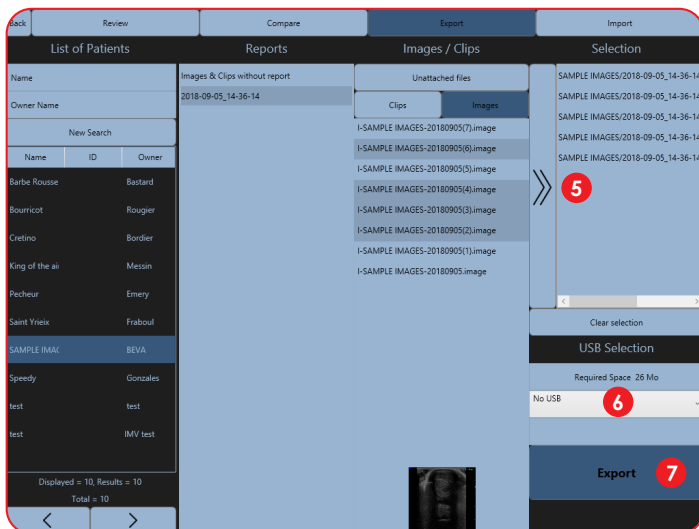
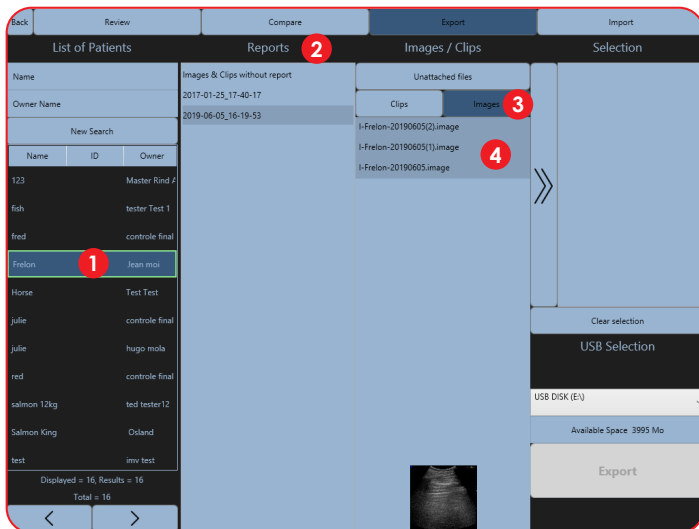

12.8 Exporting without a report

- 8 **Export/Import images or Clips:** To export a stored image or clip, open the menu Export/Import, and select the patient folder containing the images or clips you want to export.
- 9 **Patient Folders:** Select the patient folder you want to export/import images from.

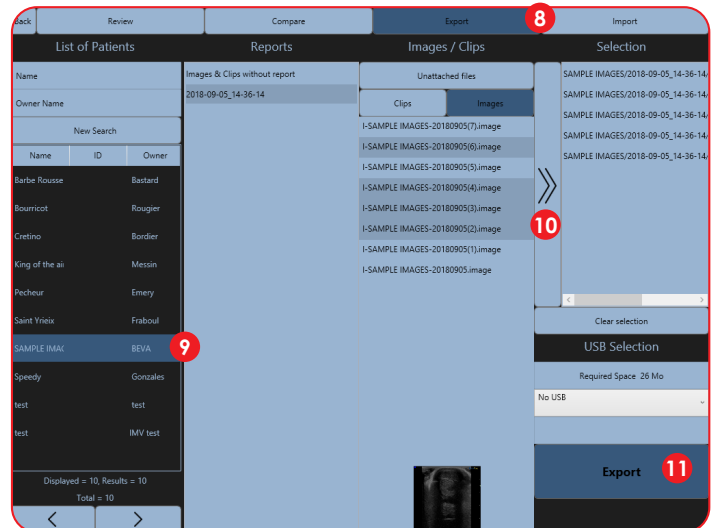

Select the Images and clips without report, select Clips or Images, and then the images and clips to export. These are then highlighted in grey. Follow the previous instructions from number 6.

All images and clips which have been stored without being part of any patient file can be exported in the same way. They will be displayed when clicking on the field "Unattached files".

12.9 Exporting a full patient

- 10 Click on the "Patient name" then press the "Selection arrow".
- 11 Press "Export", the entire patient with all its studies is exported.

12.10 Exporting a report

- 10 Click on the "Patient name", then chose a report date, then press the "Selection arrow".
- 11 Press "Export", the entire report for this patient is exported.

12. Storing of Images and Clips, Review

12.11 Compare Mode

This mode allows you to compare a current image (or a saved image) with a saved one. Compare mode is available on a frozen image or by reviewing stored images. It only compares images in B-Mode.

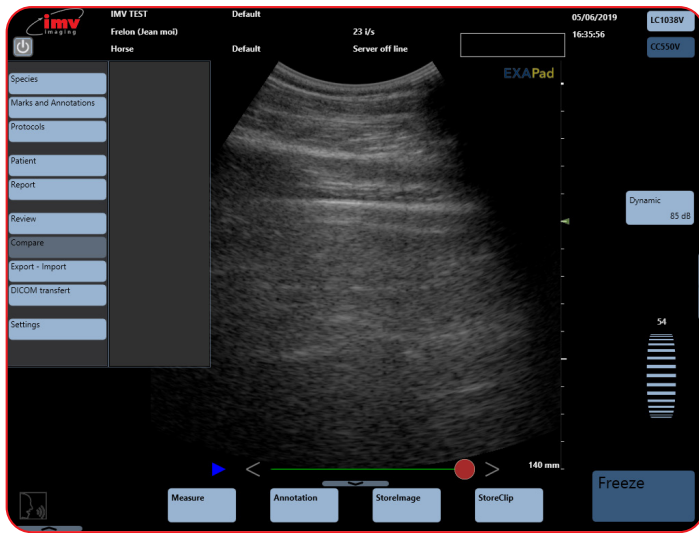

Freeze your image and go to "Compare" and select the other image you need to compare (from unattached files or even images from patients). When image is selected, press "Compare" to get the two images at the same time.

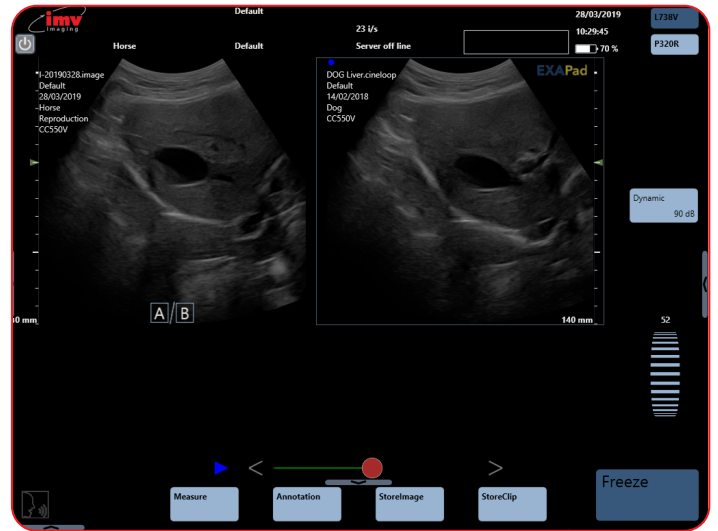
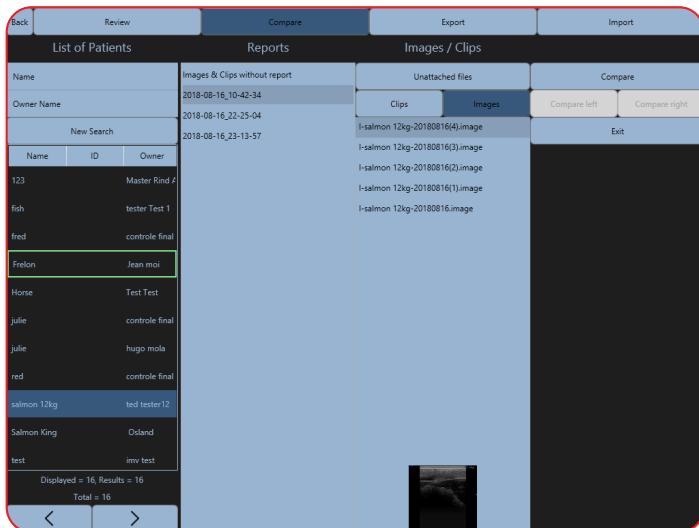

12.12 Archiving

The archiving mode allows you to export large quantities of data in order to empty space on the ultrasound system.

It is possible to archive data :

- **By Date:** enter the start date and the end date of the period you would like to archive
- **By Patient name:** Enter the name for the first patient you would like to archive and the name of the last patient you would like to archive, in alphabetical order. All patients between these two names will be archived

It is also possible to archive the unattached files that are older than one month

Delete patient after archive:

- If you activate this function patients list will be deleted after archive is successfully performed.
- If the function is un-activated the images and clips will be deleted from the machine after archiving but the database with the patient will remain in the unit.

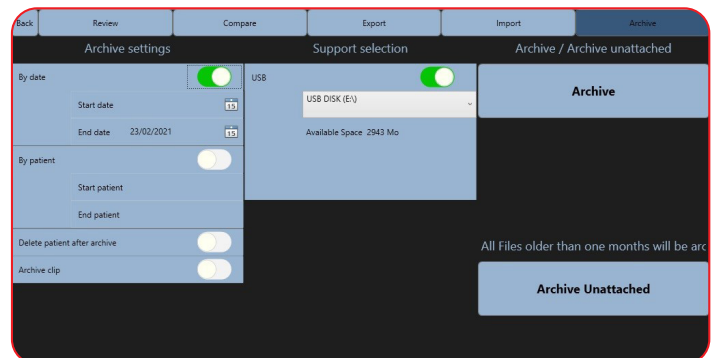

13. Measurements

Measurements can be made on live or frozen images as well as stored images.

When in Freeze mode, the measurement key appears.

When live imaging, from the menu at the bottom of the screen tap the arrow to access the "Measure" button.

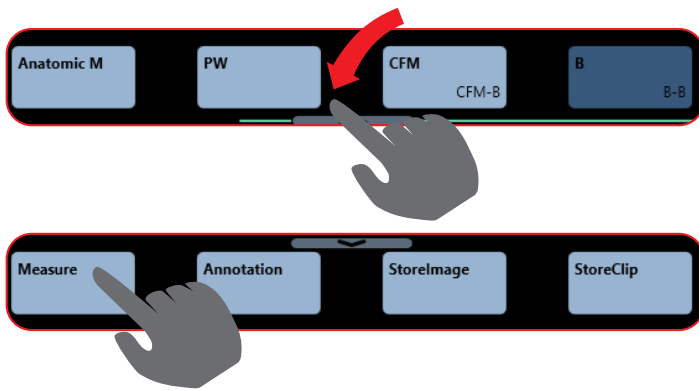

Activate/deactivate measurement controls by pressing "Measure" after freezing the image.

The available measurements depends on the imaging mode.

The measurement menu contains general measurements, for application specific measurements, use the Protocol function.

If a stored image with one or more measurements is loaded, these measurements can be corrected and or removed before the image is stored again.

13.1 Measurements in B, CFM, Power, M, Anatomic modes

13.1.1 Distance

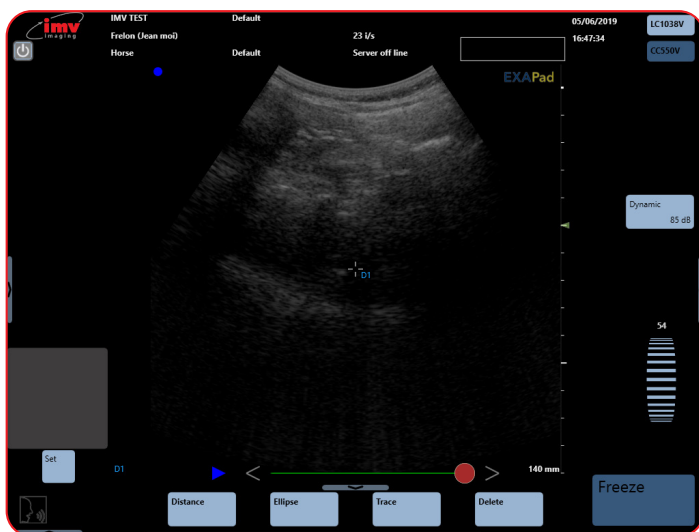

Place the first grey caliper with the touchpad in the desired place to start to measure the distance D1. Press "Set". The second caliper is now displayed.

To place the second caliper use the touch pad to place it where you want and then click "Valid" to validate the measurement.

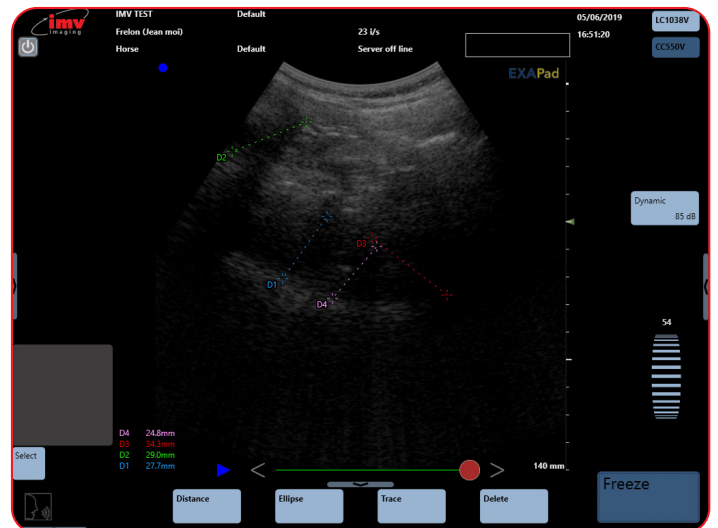
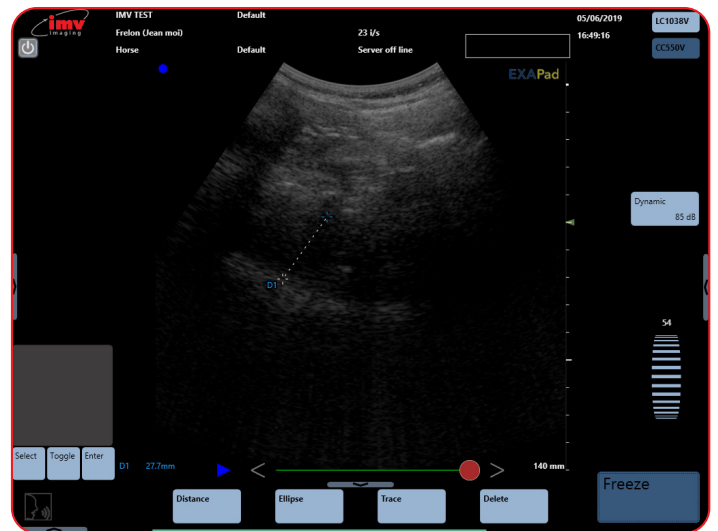

The control "Toggle" enables you to go from one caliper to the next in order to adjust the measurement before validating.

After validating, the two calipers are now displayed in blue and the result of the distance measurement is displayed in the lower left part of the screen.

To modify a measurement, press "Select" until the first measurement caliper that should be modified is displayed in a grey colour. After modifying, press "Valid" to validate.

When pressing "Distance", a second measurement can be made. Up to four distance measurements are available on one image.

13. Measurements

13.1.2 Ellipse

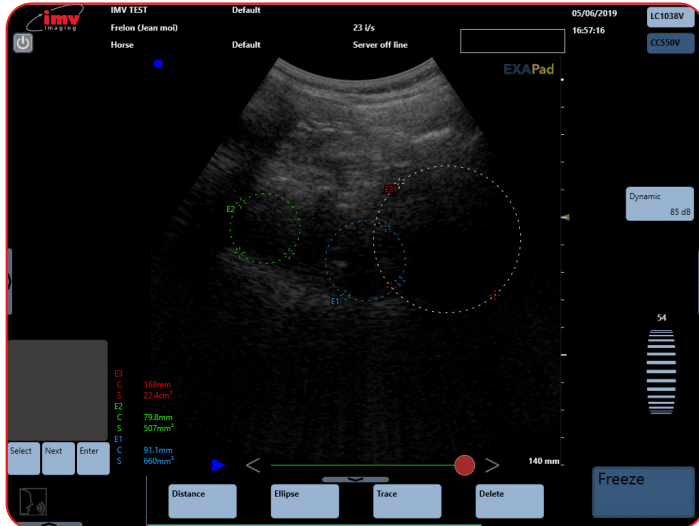

Place the first grey caliper (E1) with the trackpad to start to measure the ellipse. Press "Set". With the trackpad, draw the measurement and press "Enter" to validate.

The results of the ellipse measurement (circumference and surface) are displayed in the lower left part of the screen.

Press "Ellipse" to make another measurement. To move between modifying different Ellipse's, press "Select".

To modify a measurement, press "Next" until the caliper that should be modified is displayed in grey. After modifying, press "Enter" to validate.

Four Ellipse measurements are available on one image.

13.1.3 Trace

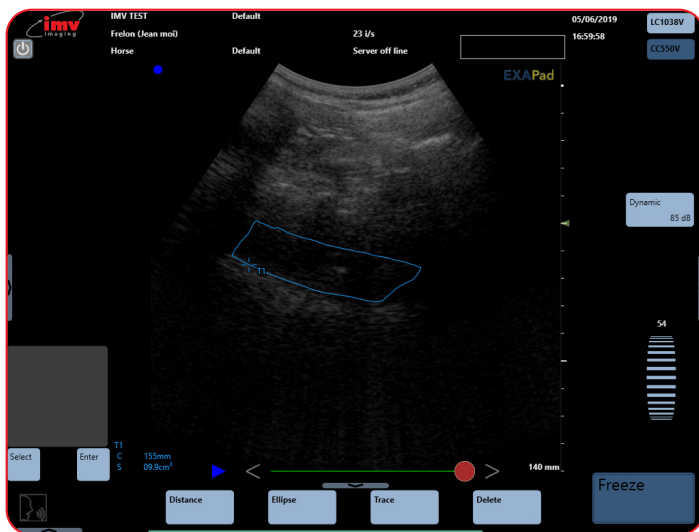

Press "Trace" in order to activate a trace measurement (circumference and surface).

Place the first grey caliper T1 with the touchpad to start the trace. Press "Set". Draw the trace with the touchpad. When the end of

the trace gets near the start, the trace will automatically close itself and the results of the trace measurement (circumference and surface) are displayed in the lower left part of the screen.

Four trace measurements are available on one image.

13.1.4 Delete

In order to delete a measurement, click on the button "Select" under the touchpad until the first caliper of the measurement that should be deleted is displayed in grey and press "Delete".

Unfreezing the image by pressing Freeze will delete all measurements.

13.1.5 Delete all

Sliding the measurement bar left will display the button "Delete all". When pressing "Delete all", all measurements are deleted without unfreezing the image.

13.1.6 Measurements in post-processing and saving

Measurements can be made in post-processing on previously stored images and sequences. Load the selected image or sequence and follow the above described procedure for making a measurement.

All measurements on stored images can be corrected and remade in post-processing, load the image with a measurement. The procedure for correction of measurements is the same as for new measurements. After correction and or remake of the measurement, the image or sequence can be stored again with the new measurement by clicking Store image or Store clip.

After correction and or remake of the measurement, the image sequence can be stored again with the new measurement by clicking "Store Image".

13.1.7 Measurements in PW-Mode

Measurement	Description	Calculations given
Automatic Measurement	Appears directly on the PW Spectrum. Scanner automatically selects the maximum number of complete cycles available on the PW spectrum. Each cycle is indicated by a Systole and Diastole detection. The cycles can be adjusted.	S (Systole speed) D (Diastole speed) Sp. Avg (Average speed) RI (Resistance Index) PI (Pulsatility Index) S/D (Systole/Diastole Rate)
Manual Measurements	Activate semi-automatic measurements. The first caliper is displayed and can be placed on the wanted systolic value.	S (Systole speed) D (Diastole speed) IR (Resistance Index) S/D (Systole/Diastole)
Flow	Measure diameter of selected vessel. It can also be done in automatic mode.	D. (Diastole speed) S. (Systole speed) Sp. avg. (Speed average) Flow
Manual Acceleration	Measure manual acceleration.	Acceleration measurement
Rate	Measurement of Cardiac rate.	Cardiac rate

Select: Start or adjust measurements.

Toggle: Move between different calipers on screen.

Enter: Validate the measurements.

Set: Confirms the first position of measurements.

All calculations are displayed in the lower right side of the screen.

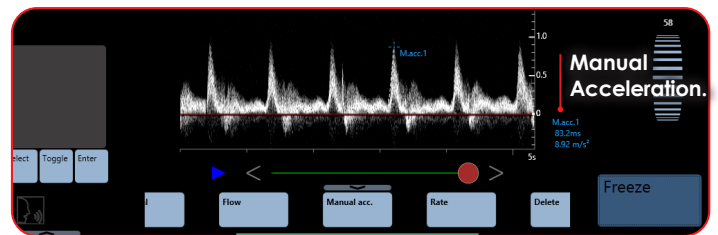
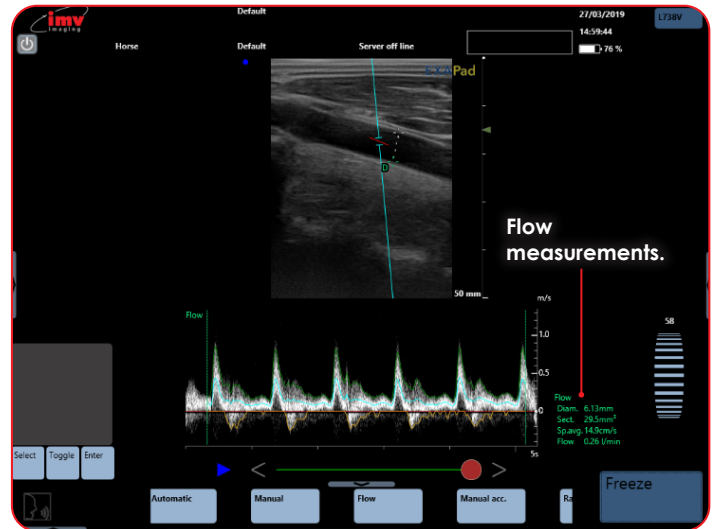
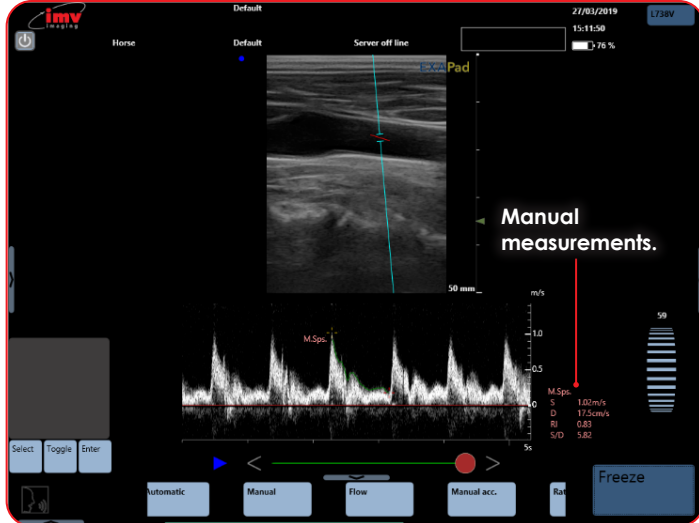
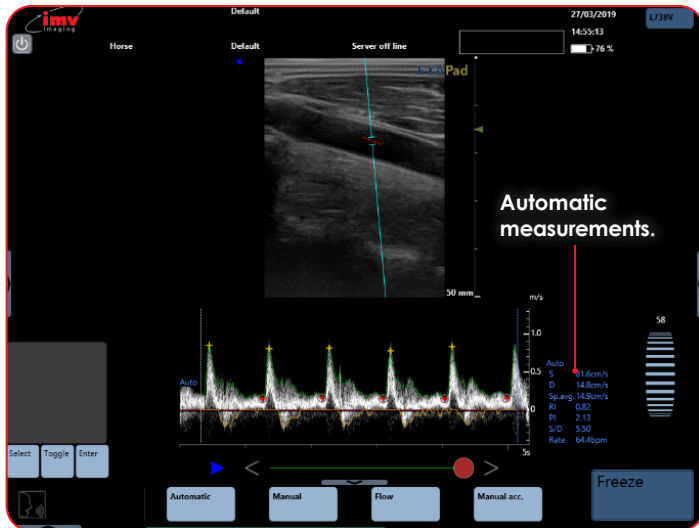

13.1.8 Delete

Press the button "Delete" in order to delete the last measurement made.

Press "Delete all" in order to delete all measurements made.

13. Measurements

13.2 Measurements in Anatomic M-Mode and TM-Mode

When live imaging, from the menu at the bottom of the screen tap the arrow to access the "Measure" button.

Freeze to make the measurement menu appear.

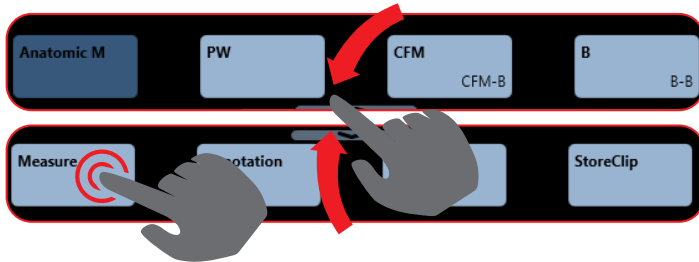

13.2.1 Time measurement

Select the measurement "Time", place the first time marker with the trackpad, press "Set" to enter the first time marker and press "Enter" to enter the second time "marker". The measurement indicates the time as well as the Cardiac rate corresponding to the measured period.

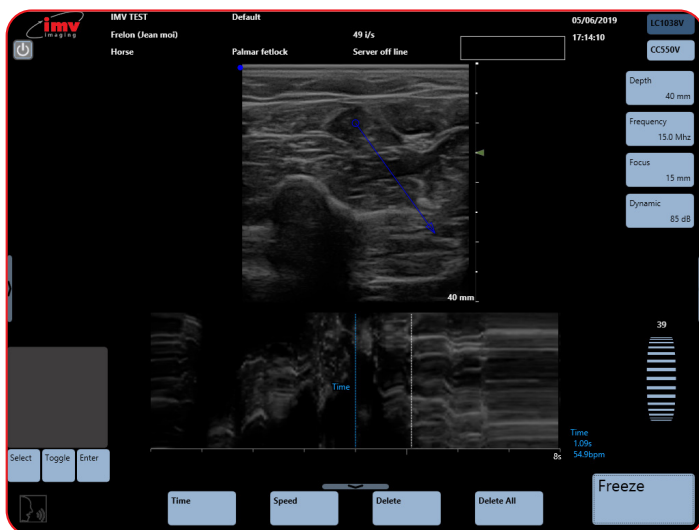
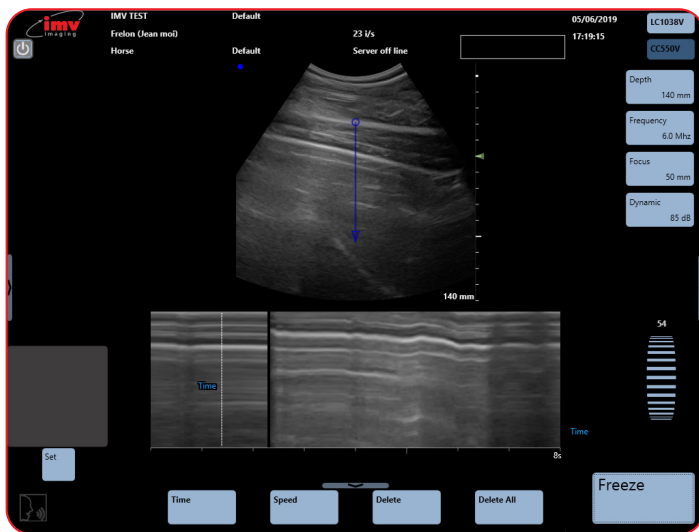

13.2.2 Speed measurement

Select the measurement "Speed" place the first caliper with the touchpad, press the button "Set" in order to place the second caliper. The measurement indicates the speed and the distance between the two callipers.

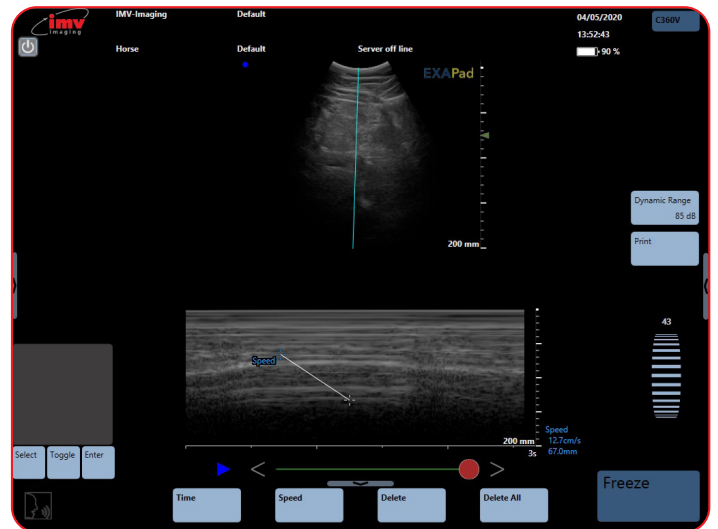
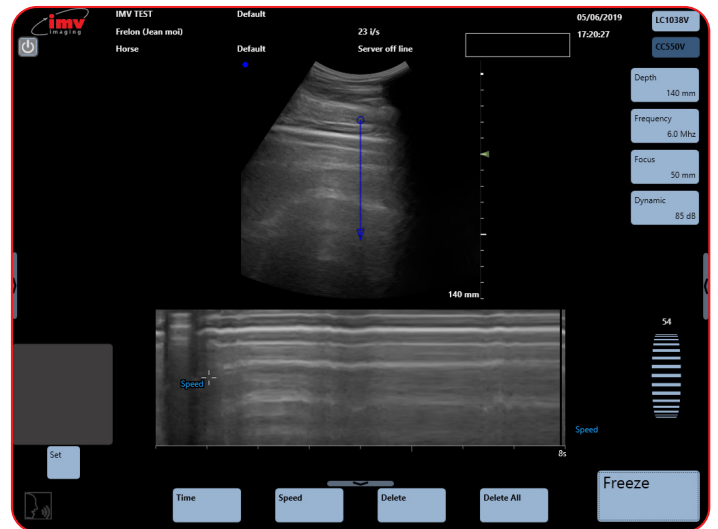

- Select/Toggle/Enter
- Press "Enter" to validate

13.2.3 Delete

Press "Delete" to delete the last measurement made.

Press the button "Delete all" to delete all measurements made.

13.3 Automatic Back Fat Measurement Option

In order to activate the automatic back fat measurement option on the ExaPad go to

Settings > System > Tools and select > Back Fat in the Dynamic tool selection section.

Once selected you can decide whether you would like to perform the measurement live on the image or only when the image is frozen. To make a live measurement, activate the "Live" mode.

The time integration allows you to decide whether you want a longer recognition time with better accuracy of measurement or a shorter recognition time with lower accuracy of measurement.

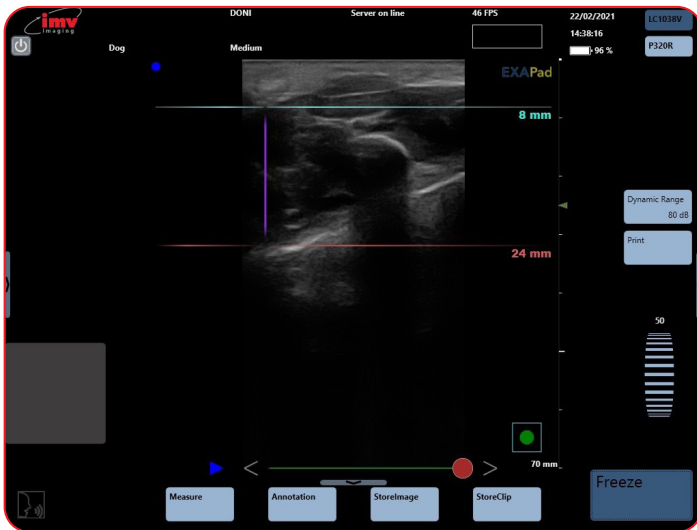
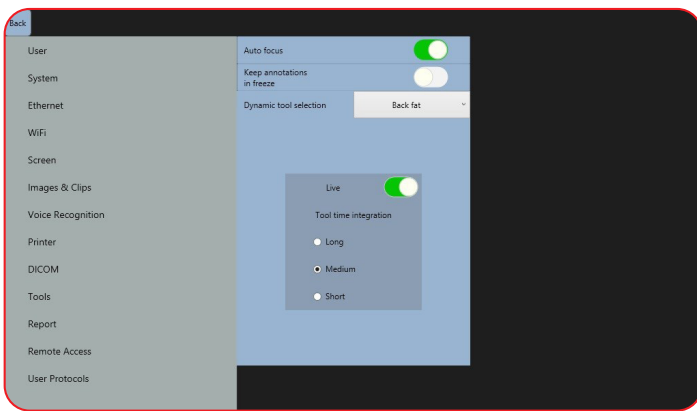

14. Applications and Presets

14.1 Species

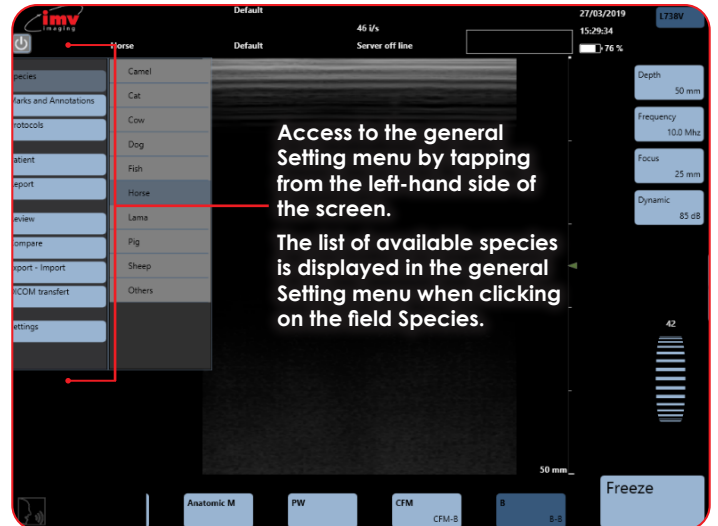

Presets

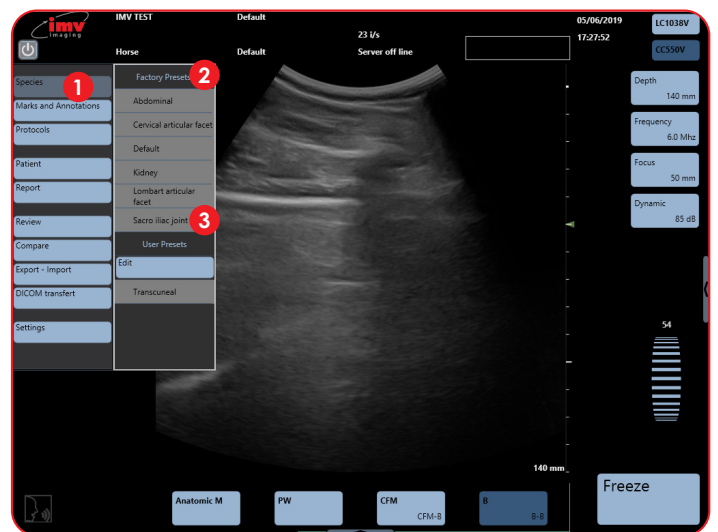

- 1 **Species:** For each Species, one or several predefined presets are stored in the device.
- 2 **Factory Presets:** The number of factory presets depends on the application.
- 3 **Select preset to load.** A preset includes all adjustable parameters and controls in all modes. When the preset has been loaded, the device returns to live imaging mode and the name of the selected species and preset is displayed on the screen. If preset is chosen when imaging is frozen, it will return to live imaging when a preset is selected.

14. Applications and Presets

14.2 Create a new preset

Adjust your system settings such as depth, frequency and gain to your preference.

Then select the wanted species in the list and click on "Edit".

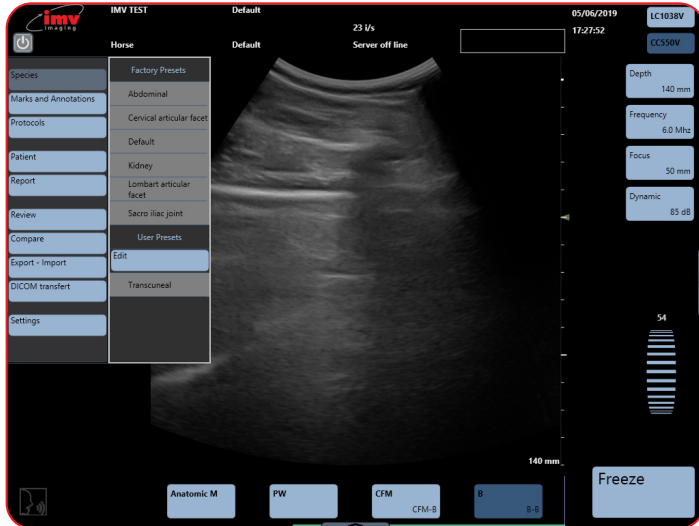

Press "New". Enter the name of the preset in the field Preset Name and confirm by pressing "Enter".

The new user preset is now created, and it is displayed in the list of presets in the "User presets" section.

Each user can create as many user presets as necessary.

14.3 Rename a preset

Select the preset that should be renamed in the list of presets, and press the field "Rename". Rename the preset in the field Preset Name and validate by pressing "Enter".

The renamed preset is displayed in the list of user presets.

Only user presets can be renamed. It is impossible to rename a factory preset made by IMV imaging.

14.4 Delete a preset

Access to the editing of presets as described above. Select the preset that should be deleted in the list of presets. Press the field "Delete" and confirm the deleting by pressing "Enter".

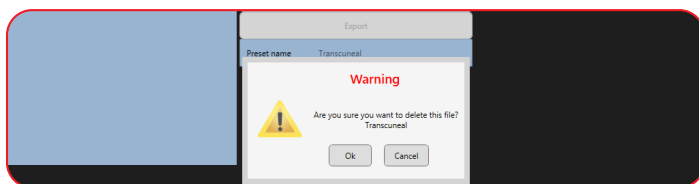

If the preset selected for delete is loaded and in use, the device will delete it and a default preset will be loaded instead.

Only user presets can be deleted. Factory presets made by IMV imaging cannot be deleted.

If a preset is renamed after a pre-existing preset, the device will ask if the user wants to override the pre-existing preset.

14.5 Favourite Presets

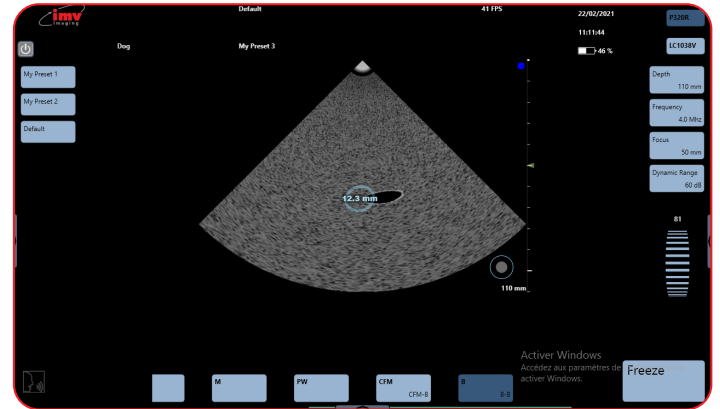

There are a maximum of 4 favourite presets per application / Probe.

Favourite presets are identified with a star in the list of presets.

Preset shortcut buttons are displayed in the majority of cases to the left of the screen symmetrically to the shortcut button parameters.

If there are only one or two favourite presets then only one or two buttons will be displayed.

Special cases: Dual, Compare, portrait. The button will display below the ultrasound image.

To Assign the Favourite property to a preset, go to Species/select a species (Dog)/Edit

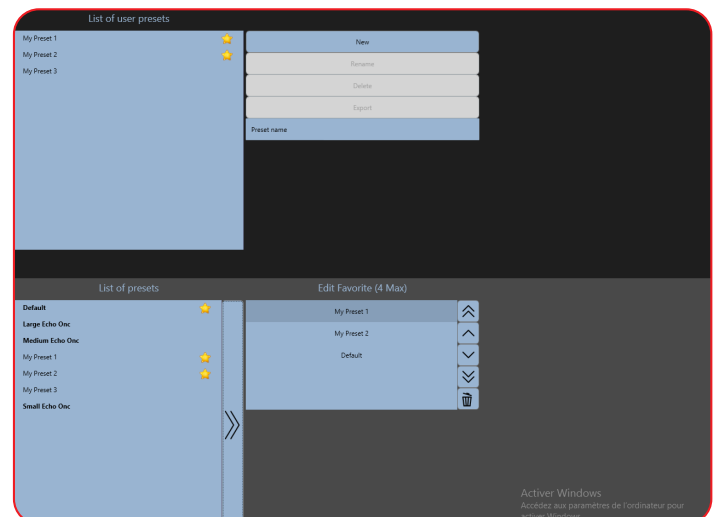

On the left is the list of Factory and Users presets.

The selected preset can be added to the favourites list with the arrow.

On the right side is the list of favourite presets.

The order of the favourite presets can be changed with the up-down arrows.

A favourite preset can be deleted from the list with the bin button.

15. Patient file

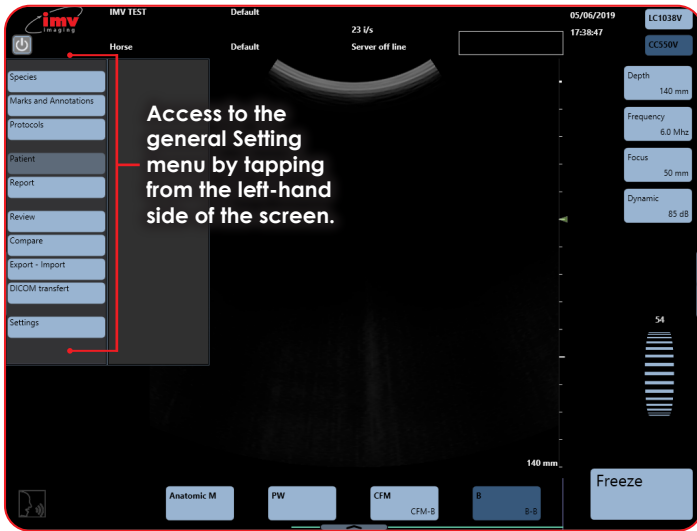

The Patient menu is made of three parts:

- Patient data base
- Patient file
- Keyboard

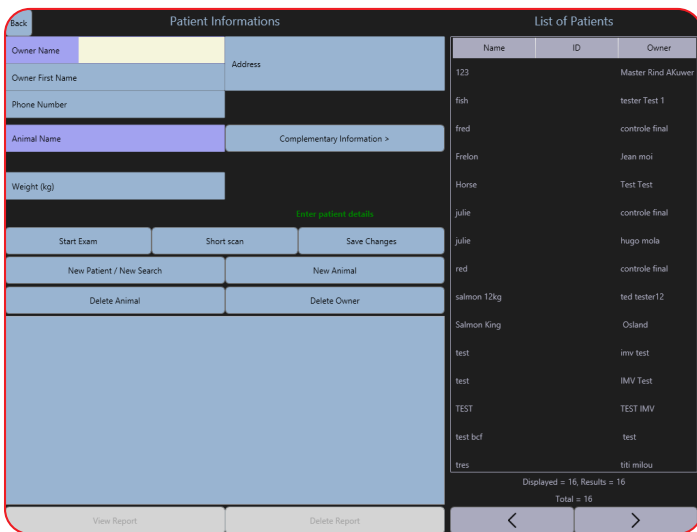

15.1 Create a new owner & animal

To create a new owner, click on the button "Owner Name".

Fill in the accessible fields. The fields "Owner Name" and "Animal Name" are necessary to be filled in.

The format of the birthdate can be modified in the Setting menu, in the sub-menu System.

When the patient fields have been filled in, the button "Short Scan" enables you to start an examination without a report.

In order to make an examination with a related report, press "Start Exam".

15.2 Create a new animal

For the current owner, to create a new animal, click the button "New Animal". Fill in the fields and click "save changes".

15.3 Search an animal

Searching for a patient in the database can be done manually by scrolling down the patient list using the arrows or by using a filter. The patients are listed alphabetically by their surnames.

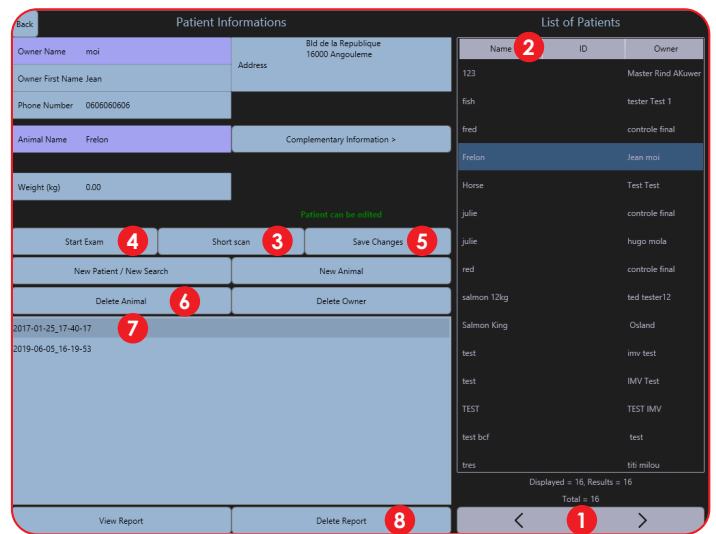

- 1 Arrows:** Search for patients using following filters; Name, Surname, Date of Birth. The arrows allow you to skip between search pages.
- 2 Name:** Select Patient.
- 3 Short Scan:** Once patient is selected, "Short Scan" for quick examination without report.
- 4 Start Exam:** Once patient is selected, "Start Exam" with report. Images and clips will be saved into "images and clips without report" for the selected patient.
- 5 Save Changes:** Modify patient information and confirm by saving changes.
- 6 Delete Animal:** Once patient is selected, press to delete its history and confirm.
- 7 Report:** Once patient is selected, select "Report" and then view report to review all reports with clips, images and measurements.
- 8 Delete Report:** Once patient and report are selected, remove by pressing "Delete Report" and "Confirm".

15. Patient File

15.4 Stopping an examination

There are two ways to stop an examination:

- Go to Report and click "Stop Examination"

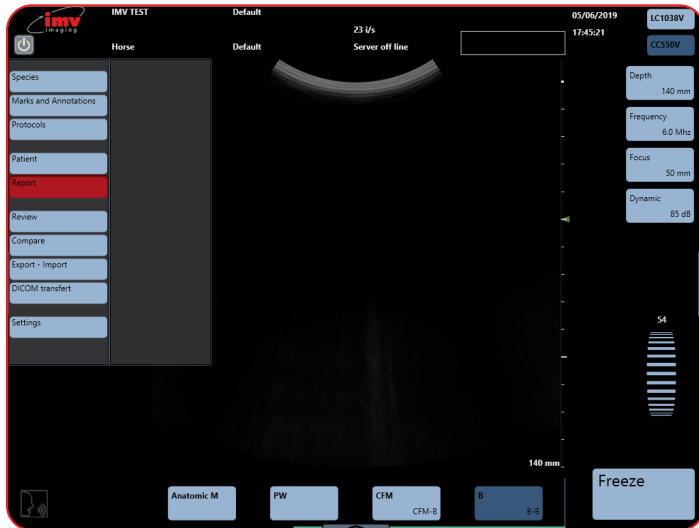

- Go to the patient file and click "Stop Exam"

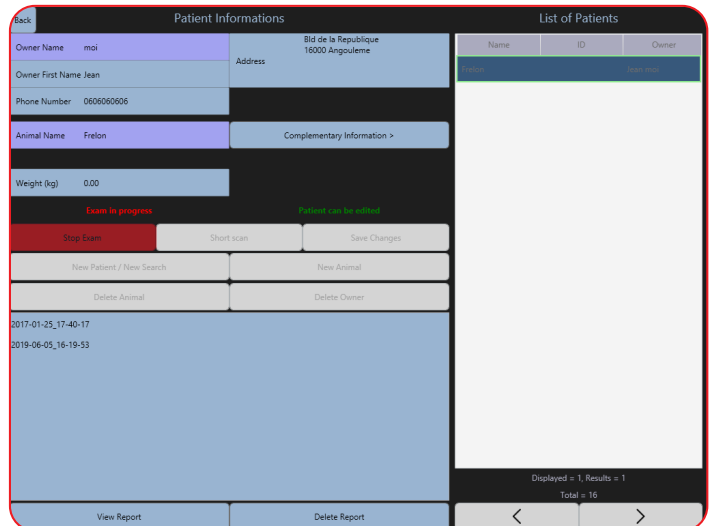
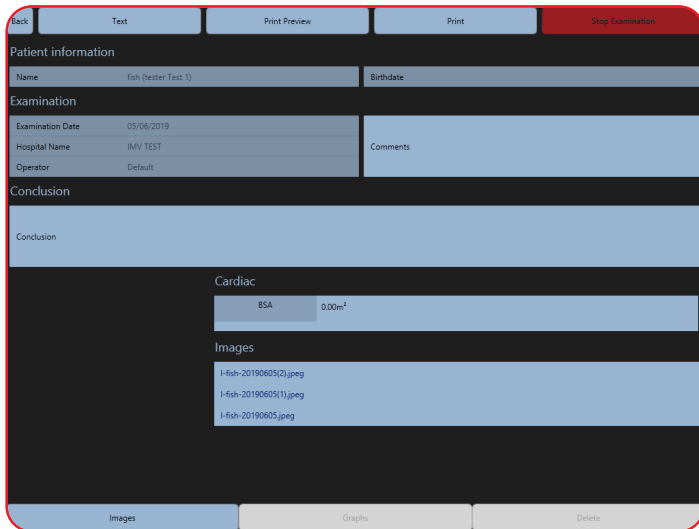
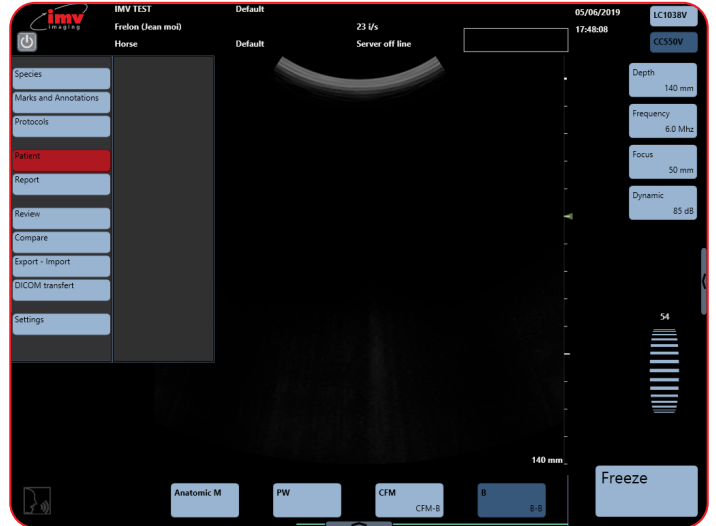

16. Protocols

16.1 Stopping a Protocol Examination

Protocols are application specific measurements, tables and calculations. The available protocols depend on the selected Species and applications.

Access Protocols by swiping across from the left-hand side of the screen.



When an examination is open, the results of each protocol measurement and table need to be manually added to the patient report by clicking "Add".

If the same measurement is made several times, the average value of these measurements is added to the protocol measurements in the patient report.

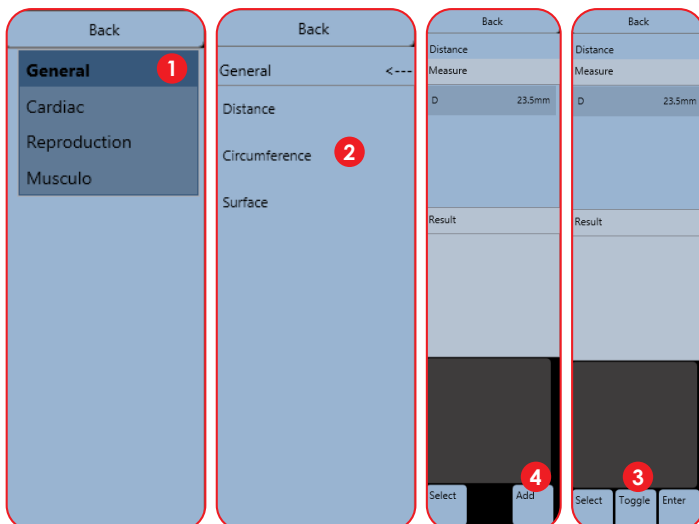

- 1 Application.
- 2 Measurement.
- 3 Tool measure on screen to realise the measurement with "Select", "Toggle", "Enter".
- 4 "Add" record the result of measurement in the report file. You can, in the same report, make different application measurements.

16.2 Protocol measurement

Select a measurement in the list of proposed measurements in the protocol.

The first caliper is displayed. Place it on the wanted place, press "Set" under the trackpad and place the next caliper(s) in the same way. Validate by pressing "Enter". Press "Toggle" if it is necessary to modify the measurement.

Press "Add" if you wish to add the measurement into the report.

For "multiple" protocol measurements, start by selecting the wanted measurement. Then make each individual measurement by selecting them one by one as indicated above. When all individual measurements are made, the global measurement is calculated.

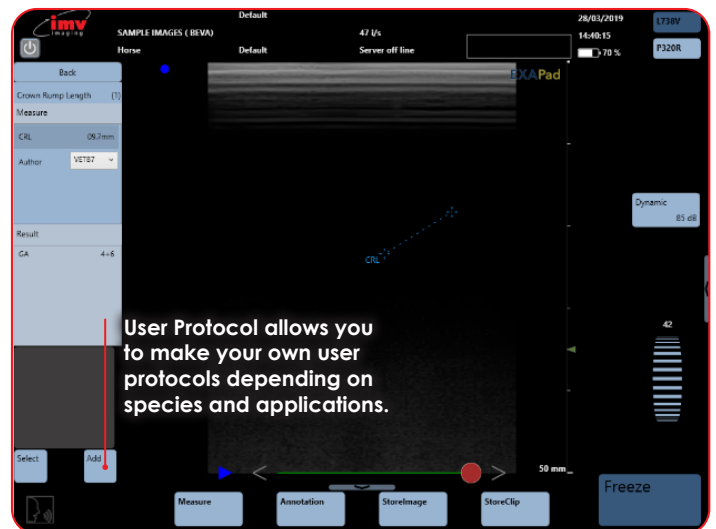

17. Webcam

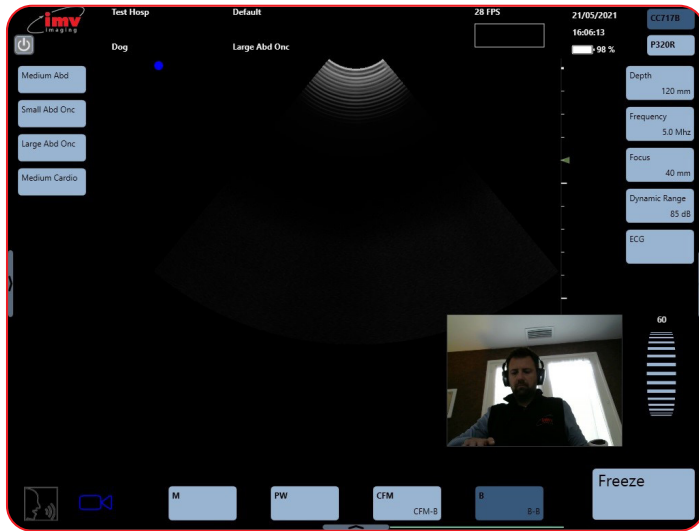

In order to activate the webcam, you first need to plug in a webcam to the ExaPad.

An icon will appear in the bottom left corner of the screen

Press the button and the webcam window will appear

It is possible to displace the webcam window by clicking in the middle of the webcam window and dragging it to the desired place.

It is possible to change the size of the webcam window. To do this, click on the side of the window and drag your finger to enlarge or shrink it.

18. Report

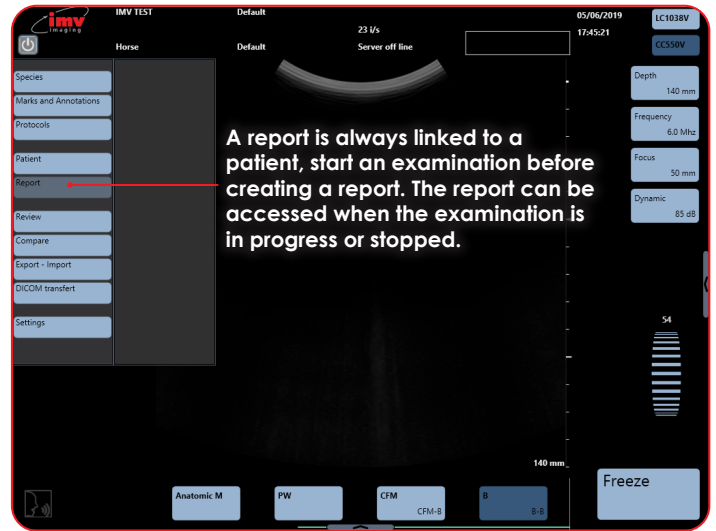

The report is displayed below:

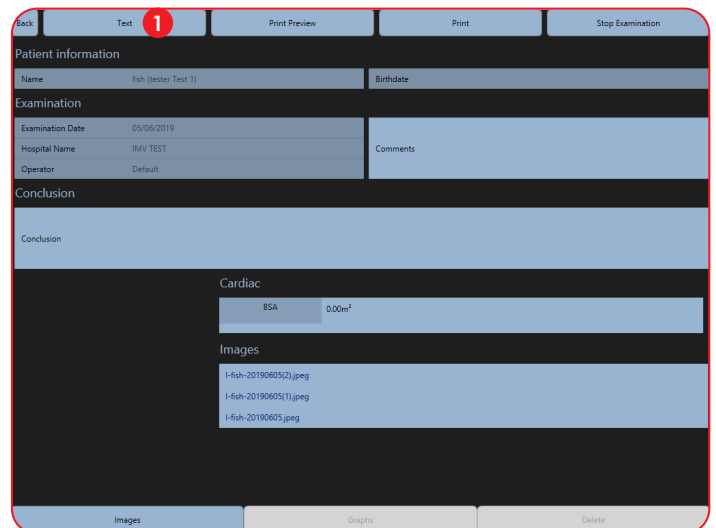

1 Text: select "Text" display to see format shown below:

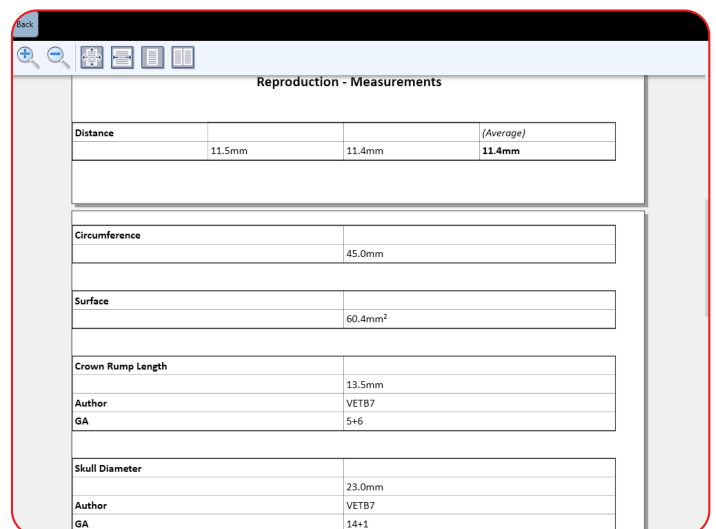

Print preview enables you to visualise the report with the layout that will be used for printing on the installed printer.

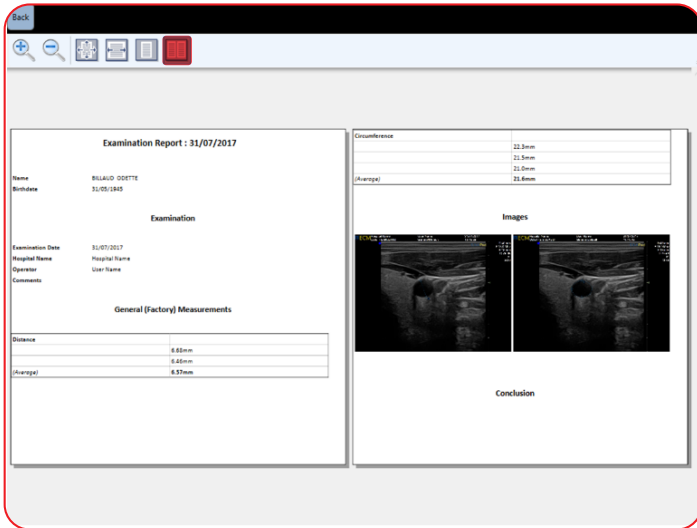

"Images" allows you to select the images that should be printed in the final report.

The ultrasound images in the report can be displayed in 1, 2 or 3 columns.

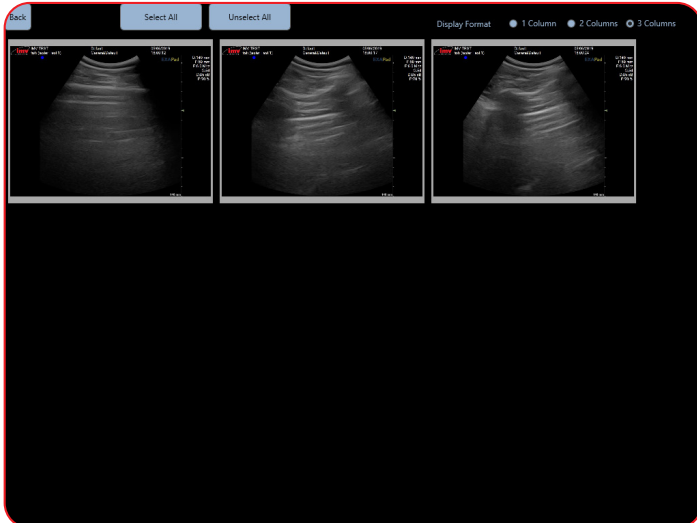

19. EchoPad App

Available on iPad only and can be accessed from the Apple App Store, the EchoPad app gives you a second command board for the ExaPad and allows for another user to view the ultrasound image in real time.

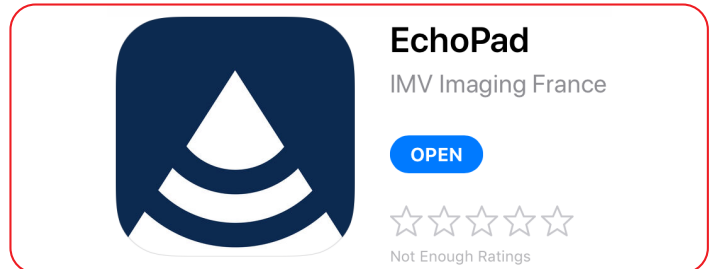

19.1 Connecting your ExaPad to an iPad

Access settings menu by tapping at the left-hand side of the screen.

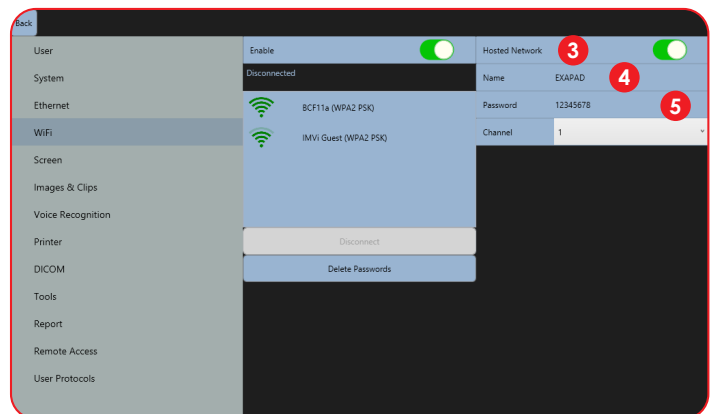
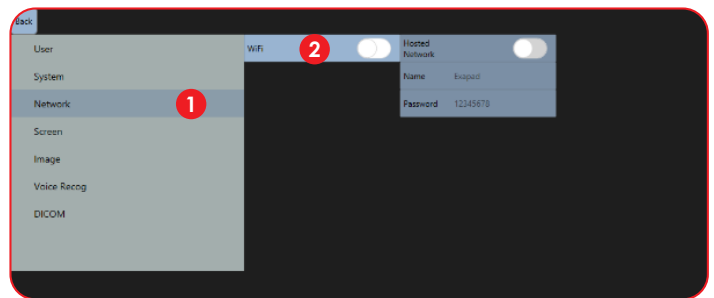

- 1 Network:** To turn Wi-Fi on.
- 2 Wi-Fi:** Ensure this button is green so that Wi-Fi is turned on.
- 3 Hosted Network:** Ensure button is green so ExaPad can connect to iPad.
- 4 Name:** Change the name of your scanner.
- 5 Password:** Enter a password, it must be 8 characters long. Default is, 12345678.

ExaPad is now ready to be connected to an iPad.

19. EchoPad App

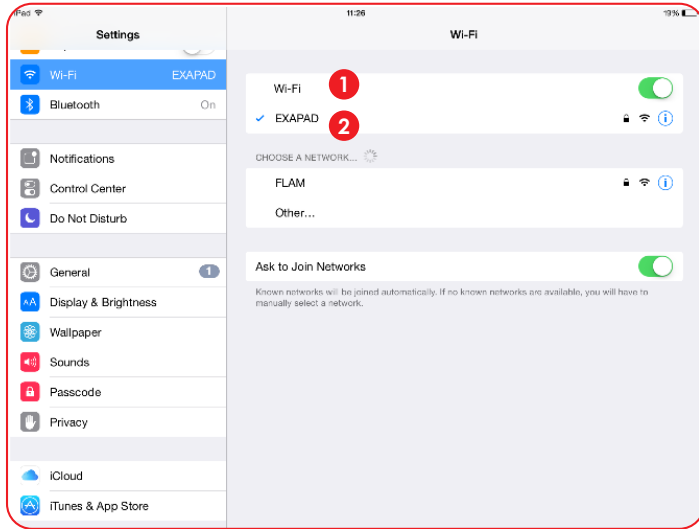

- 1 **Wi-Fi:** Within the iPad settings, ensure Wi-Fi is turned on.
- 2 **ExaPad:** Select the name of your scanner.

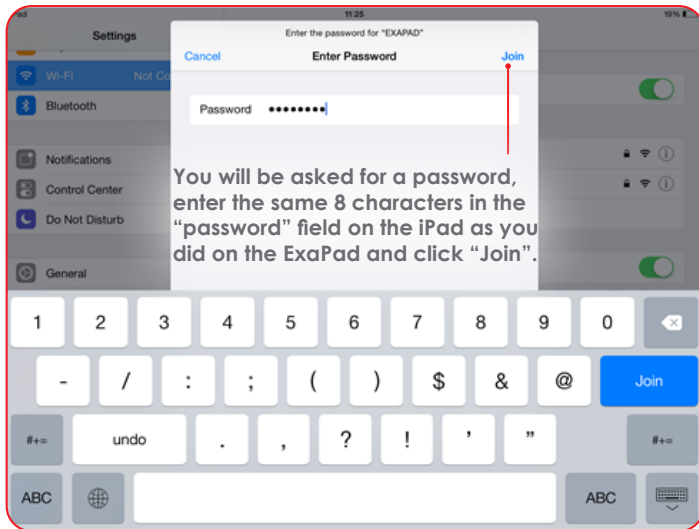

If the connection is not working, check that the network password for the ExaPad correspond to those entered for the iPad.

Open the EchoPad application on the iPad, the application will search for the ExaPad.

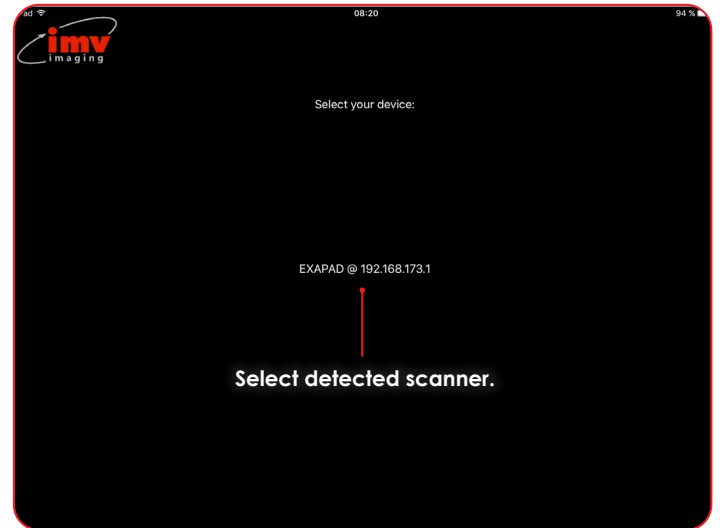

The application is now open and the remote interface of Exapad is available and ready for use on the iPad.

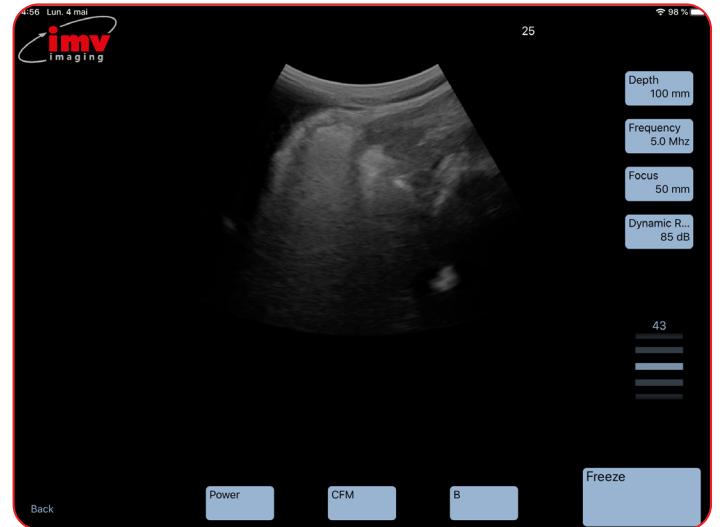

The Echopad app displays only B, CFM and Power modes. Dual images are not supported.

20. Peripheral Connectivity

The ExaPad can be connected to different peripherals such as:

- USB Peripherals (Key, Hard drive, printer, etc.)
- External HDMI video peripheral (video projector or secondary screen)
- Secondary PC via Ethernet Link

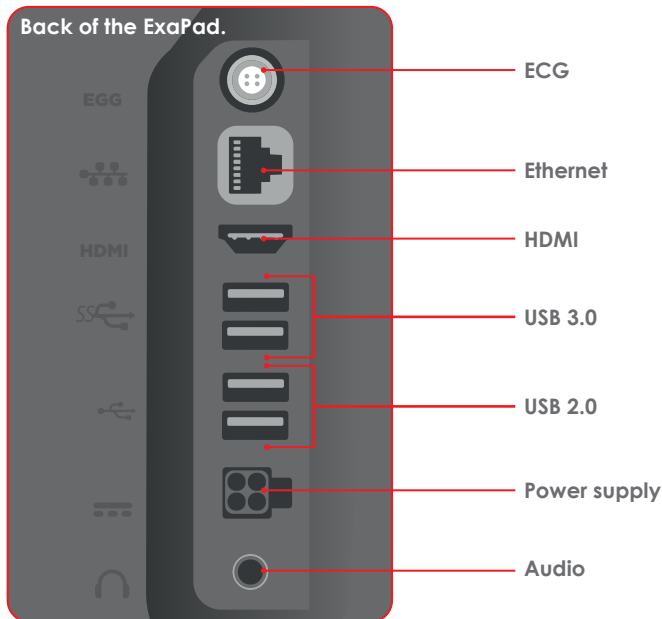

The ExaPad mini peripherals:

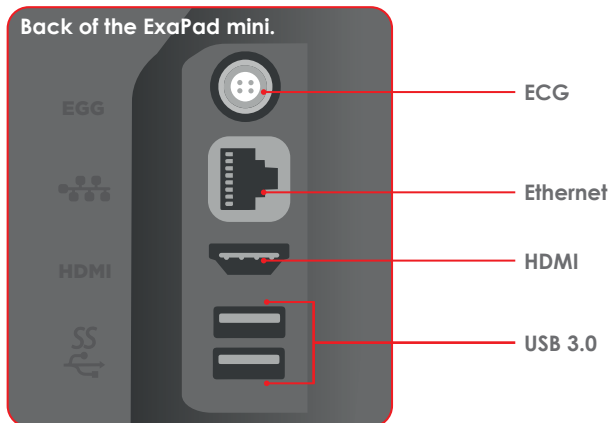

In order to ensure the security of the system:

- All the peripherals requiring a power supply (printers, screens...) must be fitted with a medical isolation transformer or be certified to conform to the electric security norm EN 60601-1-1. Should this not be the case, the electric security of the patient will not be ensured.
- Never touch a non-medical apparatus located close to the patient at the same time as the patient.
- Only exclusive use of peripheral cables prescribed by IMV imaging in this document guarantee the conformity of the ExaPad ultrasound scanner to the requirements of the electromagnetic compatibility norm EN 60601-1-2.

20.1 Remote access Login Procedure (From ExaPad or ExaPad mini)

Version 1.4 with Tixeo integrated on ExaPad and ExaPad mini

- **Step #1:** Turn the scanner on. Activate the Wi-Fi and connect the scanner to the Wi-Fi Network (Go to: Settings/Wi-Fi – search for Wi-Fi Networks and Login*) or use a cable to connect to the Internet. Make sure the scanner is connected to the Internet, not a PACS or DICOM server.
- **Step #2:** Go to: Settings/Remote Access. Press Display. Tixeo launches. Enter login information – provided by the supplier
- **Step #3:** Click on "Start Meeting". Choose your correspondent in the list that is displayed. You may want to create a correspondent if it is the first time you are using Tixeo. Make sure your correspondent has downloaded Tixeo on their PC/ Mac/Tablet or Smartphone and has a Tixeo account Press "Share" then Join the meeting



- **Step #4:** Once your correspondent has answered your call press Share, then "Full desktop". In the top bar that appears, select: (Chose the name of your correspondent)

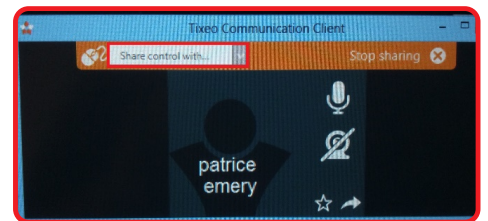
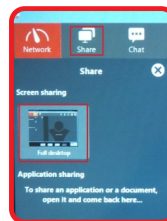

From this point your correspondent will have full control of the ExaPad.

Note: You may not have the ability to connect to the internet with the ExaPad or ExaPad Mini if your connection requires going through an internet browser (like in a hotel for example). The ExaPad and ExaPad Mini are not installed with an internet browser for security.

20.2 Remote access login procedure (from Computer)

- **Step #1:** Go www.tixeo.com and create an account with and email address. You will receive an email to finalise your account and download the software for PC or Mac
- **Step #2:** Download the software and install it on your computer.
- **Step #3:** Enter your login and password
- **Step #4:** Wait for an ExaPad to call and share control with you.

20. Peripheral Connectivity

20.3 Team Viewer Access

As default, TeamViewer is not installed on the device and the activate button is disabled.

In order to install TeamViewer on the ExaPad, the unit needs to be connected to the internet.

Press the Install button and follow the install procedure below.

Select Settings > Remote Access > Team Viewer Access > Activate. The button should now turn green.

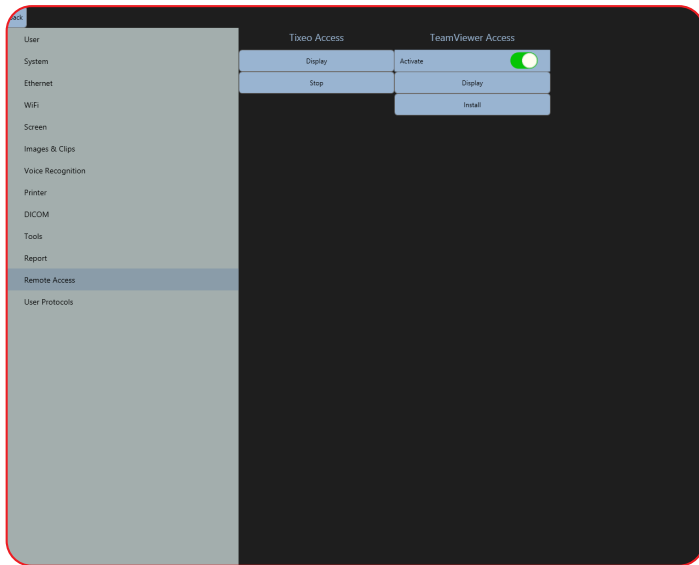

Once TeamViewer is installed, the display button is used to show the ID and the password used to connect to the ExaPad from a remote location.

The activate switch is used to enable TeamViewer on the device.

21. Care and Maintenance

21.1 Cleaning

The system is not waterproof so care should be taken to keep it away from water. The most effective and safest way to clean the ExaPad is with an antibacterial wet wipe.

21.2 Gels

Only use gel approved by IMV imaging.

21.3 Storage

Store the ExaPad in its case in dry surroundings. Ensure all interconnecting areas are clean and dry before storing.

21.4 Probes

Whilst every measure has been taken to ensure the probes are robust and fit for purpose, the probe head is still fragile and care should be taken to protect it from any knocks.

21.5 Specifications

Screen Size:	15 inch (ExaPad)
	12 inch (ExaPad mini)
Weight:	7.4kg(ExaPad)
	4kg (ExaPad mini)
Dimensions:	39x30x7cm (ExaPad)
	32x25x5.8cm (ExaPad mini)
Channels:	192 reception channels, 96 true emission channels (ExaPad)
	128 reception channels, 64 true emission channels (ExaPad mini)
Power and charging:	Interchangeable battery or on mains supply
	1 hour (ExaPad) with 'Power Save' mode enabled the batter life is extended to 1hr 30 minutes
	1 hour 30 minutes (ExaPad mini) with 'Power Save' mode enabled the batter life is extended to 2hr 15 minutes
	Battery recharging time: 3 hours (ExaPad) 2 hours (ExaPad mini)
	Mains Voltage: 100-120 Vac or 220- 240 Vac, 50/60 Hz Out Put: 150 W
	Internal voltage: Max. 19V

Probes compatibility:

Exapad Only:	Exapad and Exapad Mini:
<ul style="list-style-type: none"> • LC1038V • CC550V • LC1428V • CC717B • PC325 	<ul style="list-style-type: none"> • C360A, V,R • C614P • L738P,V • LR760V, S • C320A • L1813V • L3130B • L3180B • OPU610B • P320R • P713

22. Service Centres



If your ExaPad or ExaPad mini requires servicing please contact an official authorised service centre below or your distributor in your country. Distributors contact details can be found at www.imv-imaging.com/international

United Kingdom HQ

IMV imaging
Imaging House
Phoenix Crescent
Strathclyde Business Park
Bellshill ML4 3NJ
Scotland, UK

+44 (0) 1506 460 023
info@imv-imaging.com
www.imv-imaging.co.uk

Ireland

IMV imaging,
Unit 2, Block 3
CityNorth Business
Campus, Gormanston
Co. Meath K32 ER81
Ireland

+353 (0) 42 932 0070
ireland@imv-imaging.com
www.imv-imaging.ie

France

IMV imaging
126, Boulevard de la
République
16000 Angoulême
France

+33 (0) 5 45 92 03 57
france@imv-imaging.com
www.imv-imaging.fr

North America

IMV imaging
2900 43rd Street NW
Suite 600
Rochester
MN 55901, USA

(507) 529-8200
(800) 210-9665
F 507-529-8205
contact@imv-imaging.com
www.imv-imaging.com

South Africa

IMV imaging
6 Crieff Rd
Parkview
Johannesburg
2193

+27 82 6164685
service.rsa@imv-imaging.com
www.imv-imaging.co.za

Australasia

BCF Ultrasound
Australasia
Unit 13/23A Cook Road
Mitcham 3132 Victoria
Australia

+61 3 9874 7543
service@bcfultrasound.com
www.bcfultrasound.com

For further information on the ExaPad or ExaPad mini products visit www.imv-imaging.com/international



Contact us now

 www.imv-imaging.co.uk

 +44 (0) 1506 460023

 info@imv-imaging.com

 facebook.com/IMVimaging

 [twitter/IMVimaging](https://twitter.com/IMVimaging)

© IMV imaging, V3_06_21/ Instruction manual ExaPad

Version 1.5 ExaPad reference: 90-3346 Indice 1

User Guide EN reference: 70-3099